

# C0603C0G1H820K030BA

TDK Item Description : C0603C0G1H820KT\*\*\*\*



## Application & Main Feature

Commercial Grade ( General (Up to 50V) )

## Series

C0603 [EIA CC0201]

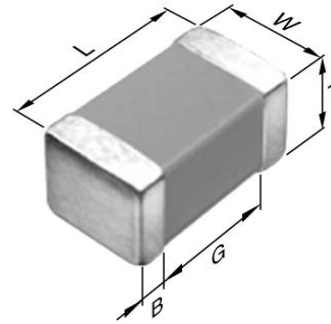

## Dimensions

L 0.60mm +/-0.03mm  
 W 0.30mm +/-0.03mm  
 T 0.30mm +/-0.03mm  
 B 0.10mm Min.  
 G 0.20mm Min.

## Temperature Characteristic

C0G (-55 to 125 degC 0+/-30ppm/degC)

## Rated Voltage

1H (50Vdc)

## Capacitance

82pF

## Capacitance Tolerance

K (+/-10%)

## Q Factor

1000 Min.

## Insulation Resistance

10Gohm Min.

## AEC-Q200

Not Applicable

**|Z|, ESR vs. Freq. Characteristics**

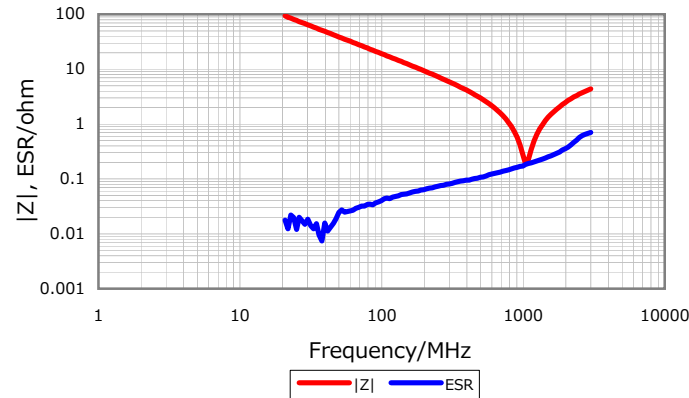

**DC Bias Characteristic**



**Cap. vs. Freq. Characteristic**

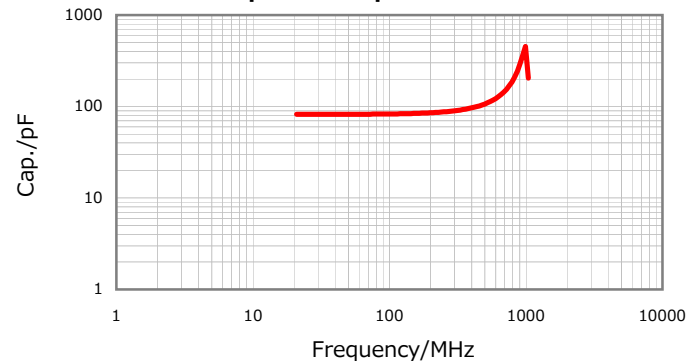

**Temperature Characteristics**



Characterization Sheet ( Multilayer Ceramic Chip Capacitors )



All specifications are subject to change without notice.

January 2, 2016