

**For General Distribution**

Issue No. : 12-SWDW-D012  
Date of Issue : October 30, 2012  
Classification :  New  Change

**PRODUCT SPECIFICATION FOR APPROVAL**

Halogen free

Product Description : Detector Switch  
Customers Part Number :  
Product Part Number : ESE18R13D  
Country of Origin : Japan  
Classification of Spec. : PRODUCT SPECIFICATION FOR APPROVAL  
Applications : For distribution sales

\* Please fill in and sign the below and return 1 copy to us

Approval No. :  
Approval Date :  
Executed by :  
\_\_\_\_\_  
(signature)  
Title :  
Dept. :

Electro-mechanical Components Business Unit  
Industrial Devices Company, Panasonic Corporation

26-1-1 Doh Tsuruga, Fukui, Japan  
Phone : +81-770-21-3625(Representative)

Prepared by : Monetary & Mechanical  
Device Development team  
Engineering Group-2

Contact Person :  
Signature H. Ogawa  
Name(Print) HIROSHI OGAWA  
Title Team Leader of Engineering  
Authorized by :  
Signature M. Onishi  
Name(Print) MASAHIDE ONISHI  
Title General Manager of Engineering



Title	COMMON PRODUCT SPECIFICATION FOR INFORMATION	Rule No. 2-1
Subject	<b>Detector Switch</b>	151-SW-0134E (R3)

## 1. Notification Items

### 1.1 Law and the regulation which are applied

- ① This product has not been manufactured with ozone depleting chemical controlled under the Montreal Protocol.
- ③ ② This product complies with the RoHS Directive (Restriction of the use of certain Hazardous Substance) in electrical and electronic equipment (DIRECTIVE 2011/65/EU).
- ③ All the materials used in this part are registered material under the Law Concerning the Examination and Regulation of Manufacture etc. or Chemical Substances.
- ④ Permission must be obtained from the Japanese government if the product that is subject to the "Foreign Exchange and Foreign Trade Law" is to be exported or taken out of Japan.

### 1.2 Application Limits

- ① This product was designed and manufactured for general electronics devices household appliances, office equipment, data and communication equipment.  
For the following applications in which high reliability and safety are required, or for the applications in which the failure or malfunction of the products may directly jeopardize life or cause threat of personal asset, please contact us beforehand.
  - Aircraft and aerospace equipment, anti-disaster or anti-crime equipment, medical equipment, transport equipment(automotives, trains, boat etc), high public information processing devices or the other equipments or devices that are equivalent to the above mentioned.
- 2 Please give us prior notification when this product is used in the products or models other than those specified in this specification. In the case where any problem occurs when this product is used in such products or models without any prior notification to us, our guarantee may not cover such a problem.
  - ② Although we are exerting our best efforts to maintain the quality of these Products, we cannot guarantee that they will never cause short circuiting and open circuitry, please do not use this switch for the function that influences the life. Therefore, when designing an equipment or device with which the priority is given to the safety, you will please carefully study the influences to the whole equipment of a single function failure of a switch in advance to make out a fail-safe design providing necessary protective circuits.
    1. Preparing a protective circuit or protective device to improve system safety, and
    2. preparing a redundant circuit to improve system safety so that the single fault of a switch does not cause a dangerous situation.
  - ① ③ Quality coverage (Immunity)
    - Please use this product within the range of the specification described in "Products Specification For Information".
    - Please acknowledge that our company and distributors cannot assume the responsibility at all beforehand about the accident and others when notes described in accident when it uses it by any chance outside the specification and "Application Notes" are not observed.

### 1.3 Handing of the delivery specification

- Writings in this specification form are subject to change through precautions.
- This specification form specify this item only. Please perform your approval test in the actual application conditions beforehand.
- The term of validity of this product specification shall be one year from the issue date.  
In case more than one year past, please request us new specifications again before ordering this product.
- After checking, put your receipt stamp or sign on the specification, and return one copy to us.  
In case that we received your order without returning the specification, we understand that you have approved the contents of the specification.

Sym 符号	Date 日付	Revision 改訂履歴	Signed 記印	Chucked 検印
△1	'09.7.29	•Addition of spec. (③Quality coverage (Immunity))	T.N	T.T.K.Y
△2	'11.11.1	•Addition of spec. (1.2 ①)	K.T	K.Y.H.O
△3	'12.8.30	•Update of EU RoHS Directive . (1.1 ② )	K.T	T.I.H.O

Title	COMMON PRODUCT SPECIFICATION FOR INFORMATION	Rule No. 2-2
Subject	<b>Detector Switch</b>	151-SW-0134E (R3)

1.4 Manufacturing Sites

**【ESE13, ESE16, ESE18, ESE21, ESE22, ESE23, ESE24, ESE58 Type】**

The country of manufacture : Japan  
 Electro-mechanical Components Business Unit  
 Industrial Devices Company, Panasonic Corporation

**【ESE11, ESE31 Type】**

The country of manufacture : China / Japan  
 Panasonic Industrial Devices (Qingdao) Co., Ltd.

Electro-mechanical Components Business Unit  
 Industrial Devices Company, Panasonic Corporation

**2.Summary**

- 2.1 This specifications applies the detector switch.
- 2.2 This specifications is a constituent document of contract for business concluded between your company and Panasonic Corporation.
- 2.3 Item not particularly specified in this specifications shall be in conformance with JIS Standards.

Sym. (符号)	Enfo. Date (実施)	Revision History (改訂履歴)	Signed	Checked	Responsible	Enacted
			(調)	(期)	(責任者)	(確認)
△						
△						
△						

Parts list (材料明細)

No. 記号	Part name 部品名	Material 材質	Remarks 記号
1	Case ケース	LCP Resin LCP樹脂	(Black color) (黒色)
2	Terminal 端子	Phosphor Bronze リン青銅条	Silver plating 銀めっき
3	Contact piece 接触片	Copper Alloy 銅合金	Silver plating 銀めっき
4	Lever レバー	LCP Resin LCP樹脂	(Black color) (黒色)
5	Frame フレーム	Stainless Steel ステンレス SUS	

Specifications 納入仕様 (スイッチに関する事項)  
 Common specification ESE1800 TYPE(1) (151-ESE-1800-1) shall apply.  
 (Except for the following items)  
 共通納入仕様書は、ESE1800形(1) (151-ESE-1800-1)による。  
 但し、下記項目は、これを優先適用する。

□ Circuit 1P1T (N.O)  
 回路構成 1回路1接点 (N.O)

- \* Contact and Insulation on dose not apply on between frame and common terminal.  
 フレームとコモン端子間の絶縁及び導通は保証しない。
- \* Contact and Insulation on dose not apply on between dummy terminal and common terminal.  
 ダミー端子とコモン端子間の絶縁及び導通は保証しない。

4.2 Operating force  $F_p = 0.3N$  max. 操作力  $F_p = 0.3N$ 以下

□ Taping package dimensions  
 テーピング寸法

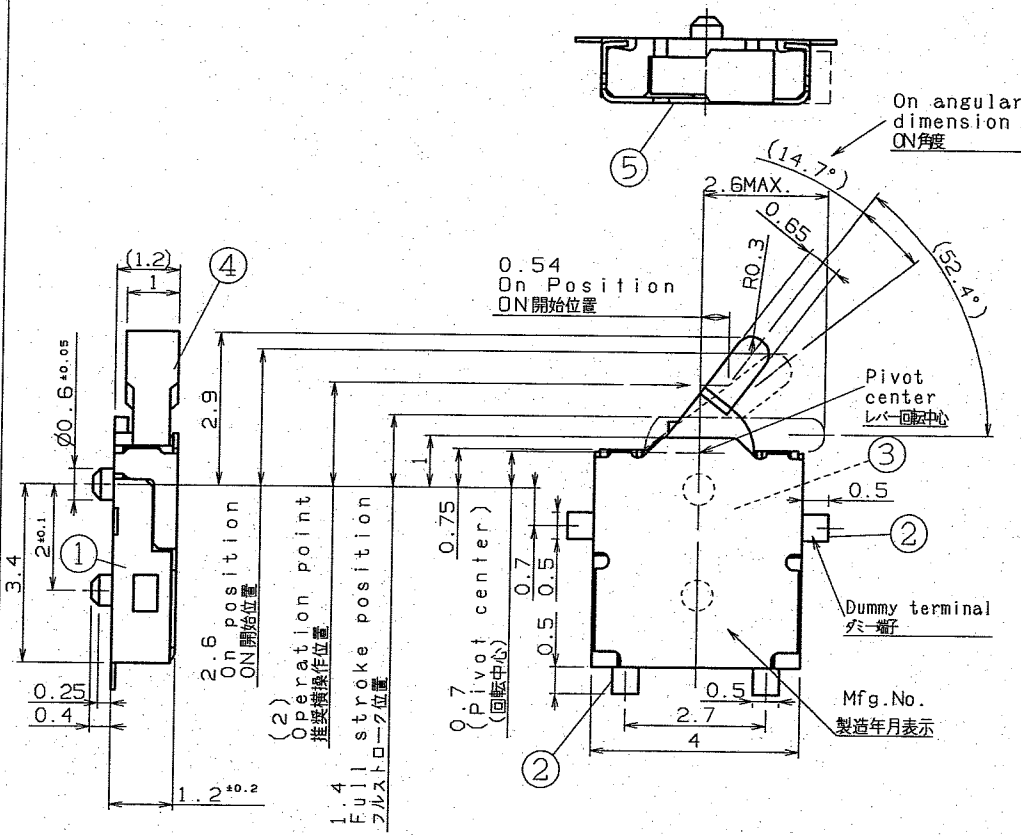
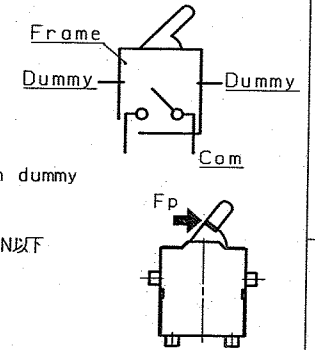

Reference land pattern  
 (Tolerance:  $\pm 0.05$ )  
 ランドパターン参考図 (公差:  $\pm 0.05$ )

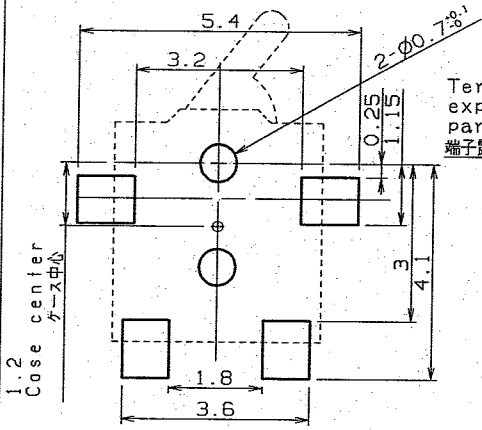



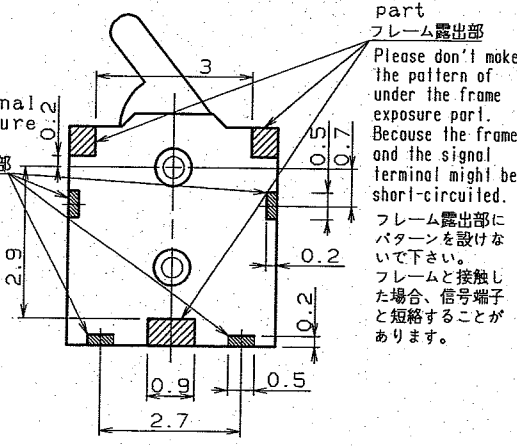

The reverse side of Case Frame exposure part  
 ケースの裏面 フレーム露出部

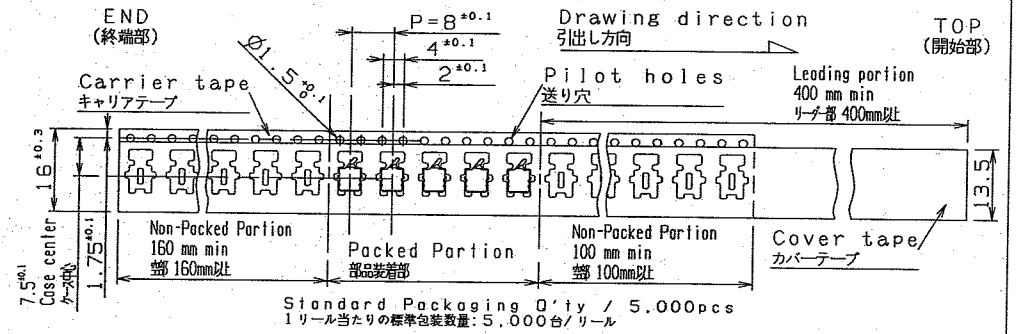

Please don't make the pattern of under the frame exposure part. Because the frame and the signal terminal might be short-circuited. フレーム露出部にパターンを設けないで下さい。フレームと接触した場合、信号端子と短絡することがあります。



No. (番号)	Item or Code No. (品名またはコード番号)	Material & Size (材質、寸法)	Q1 (数量)	Standard 標準品
± 0.3	Estab. Date (制定) '12.10.30	Enfo. Date (実施)	Enacted (検定検査) M.Ohnishi	Process (処理、加工)
Scale (尺度) 10 : 1	Designed (設計) T. Ishikawa	Drawn (製図) T. Ishikawa	Checked (検閲) K. Yasufuku	Responsible (責任者) H. Ogawa
Product Name (製品名) ESE18R13D				Part No. (品番)
Drawing No. (記号番号) 151-ESE-18R13D				Revision (版) R00
				Page (ページ) 1 of 1

Title 標準書名		COMMON PRODUCT SPECIFICATION FOR INFORMATION 共通納入仕様書			Rule No.11-1 記号番号		
Subject 品名		ESE1800Type (1) ESE1800 形 (1)			151-ESE-1800-1 (R 11)		
(Notes) (注意) 【1】 In case there are differences between the individual specifications and this specifications, priority shall be given to the individual specifications. 個別納入仕様書と本仕様書とで、矛盾が生じる項目は、個別納入仕様書を優先適用する。 【2】 Test conditions … Temperature ; 5 °C~35 °C, Humidity ; 45 %~85 %, Atmospheric pressure ; 86 kPa~106 kPa. 試験条件 … 室温 5 °C~35 °C, 相対湿度 45 %~85 %, 気圧 86 kPa~106 kPa の状態で行う。							
ITEM 項目		SPECIFICATIONS 規 格			REMARKS 備 考		
1. Appearance 外 観		There shall be no harmful plating defective, rust, cracking, chip and deformation etc., on function. 機能を損なう、めっき不良、錆、傷、割れ、変形がないこと。 There shall be no noticeable deformation in the alignment of the terminals. 端子の並びには、変形のないこと。					
2. Dimensions 寸 法		In accordance with the individual specifications. 個別納入仕様書による。					
3. Marking 表 示		In accordance with the individual specifications. 個別納入仕様書に規定する個所に、定められた内容が明瞭に表示されていること。					
4. MECHANICAL CHARACTERISTICS 機械的白勺牛守牛生							
1 Stroke ストローク		In accordance with the individual specifications. 個別納入仕様書による。					
2 Operating force 操作力		In accordance with the individual specifications. 個別納入仕様書による。					
3 Operating part strength 操作部強度		No abnormalities to apply following load on the tip of operating part for 15 s. 下記の力を操作部先端に 15 秒間加えて異常のないこと。 <input type="checkbox"/> Operating direction … 2 N 操作方向 <input type="checkbox"/> Drawing direction … 2 N 引張方向 <input type="checkbox"/> Right direction against operating direction … 2N 操作方向と直角方向					
4 Wobble of operating part 操作部ガタ		1.0mm max. to apply load 300 mN on the tip of operating part. 操作部先端に、300 mN の力を加えて 1.0 mm 以下であること。					
Sym 符号	Date 日付	Revision 改訂履歴			Signed 記 印	Checked 検 印	
	'08. 9. 1	•Deletion of spec. 仕様削除 【Sn-Pb Eutectic solder 共晶はんだ】 (6.7 Solderability はんだ付け性、6.8 Soldering heat はんだ耐熱性 ) •Addition of spec. 仕様追加 (SPECIFICATION OF TAPING PACKAGE エンボステーピング仕様) •Deletion of specifications.仕様削除 (Application Notes⑤ ご使用上の注意事項⑤ Shift of Notification Items 通知事項に移行)			K.T	K.Y Y.K	
	'09.5.15	•Change of spec. 仕様変更 (9.3 Peeling strength of cover tape カバーテープの剥離強度)			J.H	T.T K.Y	
	'09.7. 1	•Definitely of specification. 仕様明確化 (6.1 Storage temperature 保存温度範囲 )			T.N	T.T K.Y	
	'10. 2. 3	•Change of spec. 仕様変更 (8.Soldering heat : Manual soldering はんだ耐熱性:手はんだ)			J.H	T.I Y.K	
Esa. Date 制定日		Panasonic Corporation パナソニック株式会社			Check 検 印 Y. Nakase 中瀬	Check 検 印 M. Nakase 中勢	Plan 担当者 K. Minami 南

Title 標準書名		COMMON PRODUCT SPECIFICATION FOR INFORMATION 共通納入仕様書	Rule No.11-2 記号番号
Subject 品名		ESE1800Type (1) ESE1800 形 (1)	151-ESE-1800-1 (R 11)
ITEM 項目	SPECIFICATIONS 規 格		REMARKS 備 考
5	Strength of terminal and terminal plate 端子・端子板強度	No breaking of terminal and terminal plate to apply load 0.5 N in each direction on the tip of the terminal for 15 s. 端子の先端に、0.5 N の力を任意の方向に 15 秒間加えて、端子及び端子板の破損のないこと。但し、端子の曲がり・変形は判定対象外とする。	One test / One terminal 1 回試験 / 1 端子
5. ELECTRICAL CHARACTERISTICS 電気的特性			
1	Rating 定格	3 VDC 50 $\mu$ A to 5 VDC 10 mA (Resistive Load) DC3 V 50 $\mu$ A ~ DC5 V 10 mA (抵抗負荷)	
2	Contact resistance 接触抵抗	500 m $\Omega$ max after switching without load several times. Normal Open Type ... Full stroke position. Normal Close Type ... Release position. 無負荷にて数回切換えを行った後、--- 500 m $\Omega$ 以下。 NO タイプ... フルストローク状態 NC タイプ... レリーズ状態	Measuring condition 測定条件 1 kHz $\pm$ 200 Hz 20 mV, 50 mA max.
3	Withstanding voltage 耐電圧	100 V AC (50 Hz or 60 Hz) for 1 minute on between individual terminal and common terminal, between individual terminal and frame. 個別端子-コモン端子間、個別端子-フレーム間共に、AC 100 V (50 Hz or 60 Hz) 1 分間。 It dose not apply on between frame and common terminal. フレーム-コモン端子間の耐電圧の保証は行わない。	It does not apply during switching. 切換え途中は適用しない。
4	Insulation resistance 絶縁抵抗	100 M $\Omega$ min. at 100 V DC for 1 minute on between individual terminal and common terminal, between individual terminal and frame, non-continuous terminals and between outer metal part. 個別端子-コモン端子間、個別端子-フレーム間共に、DC 100 V 1 分間 100 M $\Omega$ 以上。 It dose not apply on between frame and common terminal. フレーム-コモン端子間の絶縁抵抗の保証は行わない。	It does not apply during switching. 切換え途中は適用しない。
5	Bouncing/ Chattering ハウジング/ チャタリング	10 ms max. at ordinary switching condition. (200 mm/s) 通常の切換え (200 mm/s) 状態にて、... 10 ms 以下。	
6. ENVIRONMENT CHARACTERISTICS 環境的特性			
1	Operating temperature 使用温度範囲	-10 $^{\circ}$ C to +60 $^{\circ}$ C -10 $^{\circ}$ C ~ +60 $^{\circ}$ C	
	Storage temperature 保存温度範囲	-40 $^{\circ}$ C to +85 $^{\circ}$ C -40 $^{\circ}$ C ~ +85 $^{\circ}$ C	Bulk. 単品状態
		-20 $^{\circ}$ C to +60 $^{\circ}$ C -20 $^{\circ}$ C ~ +60 $^{\circ}$ C	Taping package. テーピング状態
2	Heat resistance 耐熱性	Leave in room temperature and room humidity for an hour after placing in chamber of temperature +70 $^{\circ}$ C $\pm$ 2 $^{\circ}$ C for 96 hours. +70 $^{\circ}$ C $\pm$ 2 $^{\circ}$ C の槽中に 96 時間放置後、常温常湿中に 1 時間放置する。 <input type="checkbox"/> The contents of table-1 shall be satisfied. 表 1 を満足すること。 <input type="checkbox"/> No harmful deformation, cracking and chip etc. , on function. 機能上、有害な変形・ひび割れ・欠け等のないこと。	

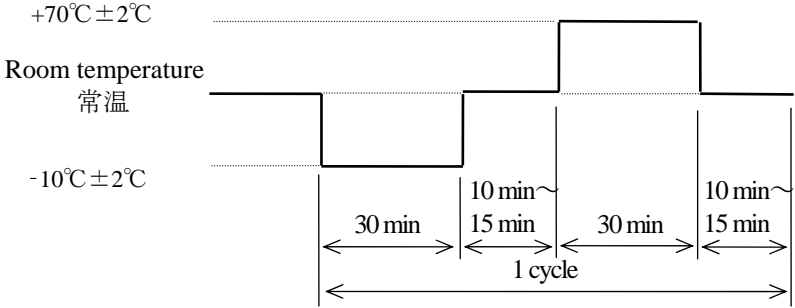
Title 標準書名	COMMON PRODUCT SPECIFICATION FOR INFORMATION 共通納入仕様書		Rule No.11-3 記号番号
Subject 品名	ESE1800Type (1) ESE1800 形 (1)		151-ESE-1800-1 (R 11)
ITEM 項目	SPECIFICATIONS 規 格		REMARKS 備 考
3 Low temperature resistance 耐寒性	Leave in room temperature and room humidity for an hour after placing in chamber of temperature $-25\text{ }^{\circ}\text{C} \pm 3\text{ }^{\circ}\text{C}$ for 96 hours. $-25\text{ }^{\circ}\text{C} \pm 3\text{ }^{\circ}\text{C}$ の槽中に 96 時間放置後、常温常湿中に 1 時間放置する。 <input type="checkbox"/> The contents of table-1 shall be satisfied. 表 1 を満足すること。 <input type="checkbox"/> No harmful deformation, cracking and chip etc. , on function. 機能上、有害な変形・ひび割れ・欠け等のないこと。		
4 Moisture resistance 耐湿性	Leave in room temperature and room humidity for an hour after placing in chamber of temperature $+40\text{ }^{\circ}\text{C} \pm 2\text{ }^{\circ}\text{C}$ and 90 %RH to 95 %RH for 96 hours. $+40\text{ }^{\circ}\text{C} \pm 2\text{ }^{\circ}\text{C}$ , 90 %RH~95 %RH の槽中に 96 時間放置後、常温常湿中に 1 時間放置する。 <input type="checkbox"/> The contents of table-1 shall be satisfied. 表 1 を満足すること。 <input type="checkbox"/> No harmful rust, deformation, cracking and chip etc. , on function. 機能上、有害な錆・変形・ひび割れ・欠け等のないこと。		
5 Endurance 耐久性	(1) No load test 無負荷試験 50,000 cycle operations with no load. (Switching speed 15 times/min to 20 times/min. ) 無負荷で、50,000 回 (開閉頻度 15 回/分~20 回/分) 往復動作する。 <input type="checkbox"/> The contents of table-1 shall be satisfied. 表 1 を満足すること。 <input type="checkbox"/> No harmful deformation, cracking and chip etc. , on function. 機能上、有害な変形・ひび割れ・欠け等のないこと。 ----- (2) load test 負荷試験 50,000 cycle operations with rated load. (Switching speed 15 times/min to 20 times/min. ) 定格負荷で、50,000 回 (開閉頻度 15 回/分~20 回/分) 往復動作する。 <input type="checkbox"/> The contents of table-1 shall be satisfied. 表 1 を満足すること。 <input type="checkbox"/> No harmful deformation, cracking and chip etc. , on function. 機能上、有害な変形・ひび割れ・欠け等のないこと。		
6 Temperature cycle test 耐温度 サイクル	Leave in room temperature and room humidity for an hour after testing 20 cycles at following condition. 下記サイクルを 1 サイクルとして、20 サイクル試験後、常温常湿中に 1 時間放置する。  <div style="text-align: center;">  <p>Room temperature 常温</p> <p><math>+70\text{ }^{\circ}\text{C} \pm 2\text{ }^{\circ}\text{C}</math></p> <p><math>-10\text{ }^{\circ}\text{C} \pm 2\text{ }^{\circ}\text{C}</math></p> <p>30 min    10 min ~ 15 min    30 min    10 min ~ 15 min    15 min</p> <p>1 cycle</p> </div> <input type="checkbox"/> The contents of table-1 shall be satisfied. 表 1 を満足すること。 <input type="checkbox"/> No harmful deformation, cracking and chip etc. , on function. 機能上、有害な変形・ひび割れ・欠け等のないこと。		

Title 標準書名	COMMON PRODUCT SPECIFICATION FOR INFORMATION 共通納入仕様書		Rule No.11-4 記号番号
Subject 品名	ESE1800Type (1) ESE1800 形 (1)		151-ESE-1800-1 (R 11)
ITEM 項目	SPECIFICATIONS 規格		REMARKS 備考
7 Solderability はんだ 付け性	<p>•Solder 使用はんだ Alloy composition 合金組成 … Sn-3Ag-0.5Cu Made by Senju Metal Industry Co.,Ltd (M705) 千住金属工業(株)製 (M705)を使用。</p> <p>•Flux フラックス CF-110VH-2A (made by TAMURA KAKEN CO.,LTD タムラ化研製.)</p> <p>•Pre-treatment 前処理 : PCT test PCT 試験 … 105 °C,100 %RH 4 h (Test shall be done in a condition of packing. 包装状態)</p> <p>•Test temperature 試験温度 : 245 °C~250 °C</p> <p>•Dipping speed 浸漬速度 : 20 mm/sec</p> <p>•Dipping depth 浸漬深さ : 1 mm~2 mm</p> <p>•Dipping an angle 浸漬角度 : Vertical direction 垂直方向</p> <p>•Test method 確認方法 : Measured the time of zero cross by Menisucograph method. Test did dip method for test balance. メニスコグラフ法によるゼロクロス時間測定 SMD 部品であるが試験安定性の為 DIP 式で実施。</p> <p><input type="checkbox"/>Solder wetting times shall be 3 s or less. はんだ濡れ時間 3 秒内。</p> <p><input type="checkbox"/>The solder shall be covered on 90 % min. of dipping area <u>on the plating surface.</u> めっき面において、浸漬面積の 90 %以上、 はんだが付いていること。</p>		Soldering process shall be done at release condition only. はんだ付け工程はリリース状態に限る。
8 Soldering heat はんだ 耐熱性	<p>Following tests shall be done in a condition of mounting on PWB. (t=1.0 mm Single sided PWB) P 基板(t=1.0 mm 片面プリント基板)に実装状態で、下記の試験を行う。</p> <p><b>【Reflow soldering リフローはんだ】</b> Test shall be done 2 times by following condition. 下記条件にて、2 回試験を行う。</p> <div data-bbox="384 1429 948 1794"> <p style="text-align: center;">Temperature profile 温度プロファイル</p> <p>The graph shows a temperature profile for reflow soldering. The y-axis represents temperature in degrees Celsius, with markers at 150~180°C, 230°C, and 250 ±5%°C. The x-axis represents time. The profile starts with a heating ramp to 250°C, followed by a dwell at 250°C for a maximum of 120 seconds. Then, it shows a cooling ramp down to a temperature range of 150~180°C, followed by a dwell at this temperature range for a maximum of 40 seconds.</p> </div> <p><input type="checkbox"/>The contents of table-1 shall be satisfied. 表 1 を満足すること。</p> <p><input type="checkbox"/>No harmful deformation on function. 機能上、有害な変形のないこと。</p>		<div style="border: 1px solid black; padding: 2px; width: fit-content;">Solder Used 使用はんだ</div> <p><b>Reflow soldering</b> <u>リフローはんだ</u> …Used Alloy composition 合金組成 Sn-3Ag-0.5Cu</p>



Title 標準書名		COMMON PRODUCT SPECIFICATION FOR INFORMATION 共通納入仕様書	Rule No.11-5 記号番号
Subject 品名		ESE1800Type (1) ESE1800 形 (1)	151-ESE-1800-1 (R 11)
ITEM 項目	SPECIFICATIONS 規 格		REMARKS 備 考
8 Soldering heat はんだ耐熱性	<p>【Manual soldering 手はんだ】</p> <p>Case material ケース材質</p> <p>◆LCP. Resin : LCP 樹脂</p> <ul style="list-style-type: none"> <li>• Shall be done at temperature 350 °C ± 10°C 3s <sup>+1</sup>/<sub>0</sub> s max. 350 °C ± 10°C 3秒 <sup>+1</sup>/<sub>0</sub> 秒以下で行う。</li> </ul> <p>◆PPHS. Resin : PPS 樹脂</p> <ul style="list-style-type: none"> <li>• Shall be done at temperature 310 °C ± 10°C 3s <sup>+1</sup>/<sub>0</sub> s max. 310 °C ± 10°C 3秒 <sup>+1</sup>/<sub>0</sub> 秒以下で行う。</li> </ul> <p>△ • Soldering iron with 60 W max. (Tip diameter: φ 1 mm max.) 60 W 以下のはんだゴテ (コテ先の径 φ 1 mm 以下)</p> <p>(Note) Soldering iron shall not be touched on resin part. Abnormal pressure shall not be apply on terminal. (注意) 樹脂部にはんだゴテが当たらないこと。 また、端子に異常加圧のないこと。</p>		<p>Flux Used 使用フラックス</p> <p>CF-110VH-2A (made by TAMURA KAKEN Co., Ltd. タムラ化研製)</p> <p><input type="checkbox"/>The contents of table-1 shall be satisfied. 表 1 を満足すること。</p> <p><input type="checkbox"/>No harmful deformation on function. 機能上、有害な変形のないこと。</p>
9 Flux proof 耐フラックス性	<p>Test shall be done in a condition of mounting on PWB (Item No. 6.8 Soldering heat : t=1.0 mm Single sided PWB).</p> <p>P 基板 (t=1.0 mm 片面プリント基板) に実装状態で、はんだ耐熱性を実施後、</p> <p><input type="checkbox"/>Flux shall be not flowed inside of switch. スイッチ内部へフラックスが流入していないこと。</p>		
10 Drop shock proof 耐落下衝撃性	<p>Drop from a height of 1m on hard board of thickness 3 cm 10 times naturally. 厚さ 3 cm の極板上に、1m の高さより 10 回自然落下を行う。</p> <p><input type="checkbox"/>The contents of table-1 shall be satisfied. 表 1 を満足すること。</p> <p><input type="checkbox"/>No harmful deformation, cracking and chip etc. , on function. Except for flaw and terminal bending. 機能上、有害な変形・ひび割れ・欠け等のないこと。 但し、傷・端子曲がりは除く。</p>		
11 Shock resistance 耐衝撃性	<p>Test shall be done at following condition.</p> <p>Acceleration : 735m/s<sup>2</sup> (75 G)</p> <p>Operating time : 6 ms</p> <p>Test direction : Each two directions of X,Y and Z directions.</p> <p>Test frequency : Every 3 times (Total 18 times)</p> <p>加速度:735m/s<sup>2</sup> (75 G) 作用時間:6 ms 試験方向:X,Y,Z 各 2 方向 試験回数:各 3 回(計 18 回)の試験を行う。</p> <p><input type="checkbox"/>The contents of table-1 shall be satisfied. 表 1 を満足すること。</p> <p><input type="checkbox"/>No harmful deformation, cracking and chip etc. , on function. 機能上、有害な変形・ひび割れ・欠け等のないこと。</p>		
12 Vibration Proof 耐振性	<p>Vibration of amplitude : 1.5 mm, f=10 Hz~55 Hz~10 Hz and the period : 1 minute shall be done in X,Y and Z direction for respective 2 hours. 振幅 : 1.5 mm, f=10 Hz~55 Hz~10 Hz, 周期:1 分間の振動を X,Y,Z 方向に、各 2 時間行う。</p> <p><input type="checkbox"/>The contents of table-1 shall be satisfied. 表 1 を満足すること。</p> <p><input type="checkbox"/>No harmful deformation, cracking and chip etc. , on function. 機能上、有害な変形・ひび割れ・欠け等のないこと。</p>		



Title 標準書名	COMMON PRODUCT SPECIFICATION FOR INFORMATION 共通納入仕様書	Rule No.11-6 記号番号
Subject 品名	ESE1800Type (1) ESE1800 形 (1)	151-ESE-1800-1 (R 11)
ITEM 項目	SPECIFICATIONS 規格	REMARKS 備考
13 Hydrogen sulfide resistance 耐硫化性	Place in chamber of +40 °C ± 2 °C, 90 %RH to 95 %RH and 3 ppm ± 0.5 ppm H <sub>2</sub> S for 96 hours. +40 °C ± 2 °C, 90 %RH ~ 95% RH, H <sub>2</sub> S 3 ppm ± 0.5 ppm の槽中に 96 時間放置する。 <input type="checkbox"/> The contents of table-1 shall be satisfied. 表 1 を満足すること。 <input type="checkbox"/> No harmful rust, deformation, cracking and chip etc. , on function. 機能上、有害な錆・変形・ひび割れ・欠け等のないこと。	
14 Joint strength of solder はんだ 接合強度	<ul style="list-style-type: none"> <li>• Solder 使用はんだ : Alloy composition 合金組成 … Sn-3Ag-0.5Cu Made by Senju Metal Industry Co.,Ltd (M705-221BM) 千住金属工業(株)製 (M705-221BM)を使用。</li> <li>• Solderability condition はんだ付け条件 : <ul style="list-style-type: none"> <li>… Pre-heat 予備加熱 : 150 °C ~ 170 °C, 60 s ~ 120 s</li> <li>… Heat 本加熱 : 230 °C min., 30 s ~ 40 s</li> <li>… Peak ピーク : 245 °C ~ 250 °C</li> </ul> </li> <li>• Temperature cycle 温度サイクル : <ul style="list-style-type: none"> <li>… Test cycle 試験サイクル数 : 1000 cycle</li> <li>… 1 cycle : Peak temperature ピーク温度 -25 °C ± 3 °C, 70 °C ± 2 °C Time to hold peak temperature is more than 7 minute. ピーク温度保持時間 各 7 分以上</li> </ul> </li> </ul> <input type="checkbox"/> Average change ratio of robustness after temperature cycle.... 50 % or less. 温度サイクル後、固着性強度の平均変化率 .... 50 % 以下	

【Table-1 表 1】

Contact resistance 接触抵抗	Voltage drop 電圧降下 … max. 1.5 V (Contact resistance 接触抵抗 … max. 15 kΩ) As shown in Fig.1 図 1 参照 ※ Condition: Voltage 5V, Pull up resistance: 47 kΩ 条件: 電圧 5 V, プルアップ抵抗 47 kΩ
Bouncing / Chattering ハウジング / チャタリング	15 ms max. as shown in Fig. 1 15 ms 以下 図 1 参照
Insulation resistance 絶縁抵抗	100 V DC 10 MΩ min. DC 100 V 10 MΩ 以上
Withstand voltage 耐電圧	100 V AC for 1 minute AC 100 V 1 分間
Operating force 操作力	500 mN max. 500 mN 以下

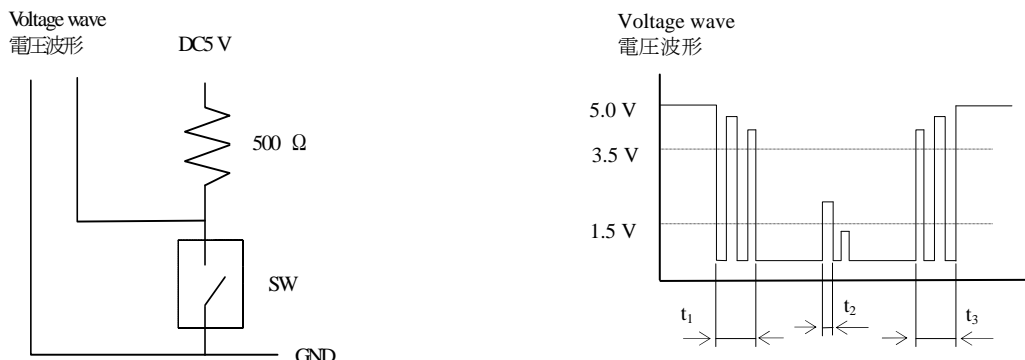
【Fig-1 図 1】 t<sub>1</sub>, t<sub>3</sub>: Bouncing ハウジング t<sub>2</sub>: Chattering チャタリング

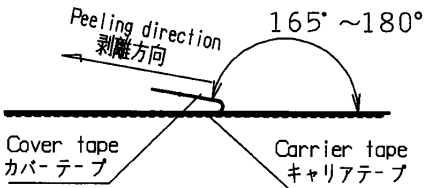

Title 標準書名	COMMON PRODUCT SPECIFICATION FOR INFORMATION 共通納入仕様書	Rule No.11-7 記号番号
Subject 品名	ESE1800Type (1) ESE1800 形 (1)	151-ESE-1800-1 (R 11)
 SPECIFICATION OF TAPING PACKAGE エンボステーピング仕様		
ITEM 項目	SPECIFICATIONS 規 格	
7. Scope 適用範囲	<p>This specification outlines engineering information of the taping package for switches. In case there are differences between the individual specification and this specification, priority shall be given to the individual specification</p> <p>当仕様書は、エンボステーピング対応製品のテーピング仕様について適用する。 個別納入仕様書と当仕様書とで矛盾が生じる項目は、個別納入仕様書を優先適用する。</p>	
8. Appliance 適用機種	<p>Shall be applied to parts of embossed taping package. エンボステーピング対応製品に適用する。</p>	
9. Specification of taping package テーピング仕様		
1 Dimensions テーピング寸法	<p>In accordance with individual specification. 個別納入仕様書による。</p>	
2 Protrusion of cover tape カバーテープのはみ出し	<p>① Cover tape shall not protrude on the pilot holes. パイロット穴にカバーテープがはみ出していないこと。</p> <p>② Protrusion of cover tape from carrier tape shall be 0.1 mm max. キャリアテープ幅に対してカバーテープのはみ出し。… 0.1 mm 以下</p>	
3 Peeling strength of cover tape カバーテープの剥離強度 (Refer to conform with JIS C 0806-3) (JIS C 0806-3 に準ずる)	<p>Tested as follows, peeling strength of cover tape shall be 0.1 N ~ 1 N. 下記の試験条件で測定して、剥離強度は、0.1 N ~ 1 N のこと。</p> <div style="display: flex; align-items: center;"> <div style="margin-right: 20px;"> <p></p> <p><input type="checkbox"/> Peeling direction … as follows 剥離方向 図示とおり</p> <p><input type="checkbox"/> Peeling speed … 300 mm. / min. 剥離速度</p> <p><input type="checkbox"/> Peeling angle … 165° ~ 180° 剥離角度</p> </div> <div>  </div> </div>	
4 Tensile strength of taping package テープの引張り強度	<p>Tensile strength of taping package after sealing shall be 10 N minimum. No tearing off and peeling off of taping package shall exist.</p> <p>シール後のテープの引張り強度は、… 10 N 以上のこと。 また、この時テープの破断、シールはがれのないこと。</p>	
5 Detachable characteristics 部品の抜取性	<p>① Switch shall fall freely from the reversed carrier tape after the switch pushed at 100 mN~200 mN. (No adhesion by grease) スイッチを軽く(100 mN~200 mN)押し込んだ後、キャリアテープを逆さにして、スイッチが自然落下すること。 (接点潤滑剤による、粘着のないこと。)</p> <p>② Switch shall not adhere on cover tape at the peeling of the cover tape. カバーテープの剥離時に、カバーテープにスイッチが付着していないこと。</p>	
6 Lacking of parts 部品の欠品	<p>There shall be no lack in packing. スイッチの部品欠品のないこと。</p>	

Title 標準書名	COMMON PRODUCT SPECIFICATION FOR INFORMATION 共通納入仕様書	Rule No.11-8 記号番号
Subject 品名	ESE1800Type (1) ESE1800 形 (1)	151-ESE-1800-1 (R 11)

ITEM 項目	SPECIFICATIONS 規格
------------	----------------------

1 Specification of reel  
0. リール仕様

1 Dimensions  
リール寸法

W dimension W 寸法	16.4 <sup>+2</sup> / <sub>0</sub>
---------------------	-----------------------------------

2 Indication  
リール仕様

Following items shall be indicated on the reel.  
Customer's part No. Panasonic Part No. Quantity Manufacturing lots.  
Company's name or Trade mark  
リール表面に下記項目が表示されていること。  
(ユーザー品番:指定のある場合のみ)、当社品番、数量、製造ロット、当社社名又は略号

Title 標準書名	COMMON PRODUCT SPECIFICATION FOR INFORMATION 共通納入仕様書	Rule No.11-9 記号番号
Subject 品名	ESE1800Type (1) ESE1800 形 (1)	151-ESE-1800-1 (R 11)



## Application Notes

### ご使用上の注意事項

When using our Detector Switches, please observe the following items ("prohibited items") and be cautions of the Following in order to prevent dangerous accidents and deterioration of performance.

ご使用に際しては、不安全事故や性能劣化等の未然防止のため、以下の禁止事項の厳守と注意事項についてご配慮ください。

#### ① Prohibited items and notes on mounting

##### 実装に関する禁止及び注意事項

- (1) When soldering (including preheat), set the lever to the release position.  
はんだ付けする際(プリヒート含む)は、操作部(レバー)をリリース状態にして行ってください。
- (2) Do not dip-solder after reflow-soldering to prevent from jumping flux.  
フラックス上がり防止のため、リフローはんだをした後、ディップはんだはしないでください。
- (3) Since the detector switches are not sealed, do not wash them.  
スイッチは密閉構造になっていないため、洗浄はしないでください。
- (4) With the switch installed on the printed wiring board, do not stack the boards.  
プリント配線板に実装後、基板の積重ねをしないでください。

#### ② Notes on circuit conditions

##### 回路条件に関する注意事項

- (1) To ensure reliability, use detector switches within the rated range, as designated in "Product Specifications for Information."  
"信頼性確保のため、納入仕様書で規定している定格の範囲内でご使用ください。
- (2) To avoid malfunction of a set due to bounce generated by turning the switch ON and OFF, and/or due to chatter generated by external vibrations, etc., take the following into consideration in design.  
スイッチの ON 又は OFF への切換え動作時のハウジング及び外部振動時等のチャタリングによるセットの誤動作を防止するために、下記のような設計配慮をお願いします。
  1. Reading twice or more. (At the microcomputer processing)  
複数回の読み込みを行う。(マイコン処理の場合)  
(Recommendation : Reading three times or more at the cycle of 3ms or more.)  
(推奨: 3 ms 以上の周期で 3 回以上の読み込み)
  2. Installing CR integration circuit.  
CR 積分回路を設置する。  
(Recommendation : Time constant 6ms or more.)  
(推奨: 時定数 6 ms 以上)

#### ③ Prohibited items and notes on mounting and operating conditions

##### 取付け及び使用条件に関する禁止及び注意事項

- (1) Design so that the load applied to the lever during operation is within the rated range of the Switch's lever strength.  
ご使用の際、操作部にかかる力は、スイッチの操作部強度の規格範囲内で行えるように設計してください。
- (2) As a rule, operate the lever center parallel to the move the switch.  
原則として、スイッチはレバーの中心を平行に操作して下さい。
- (3) Design and use that external stress is not applied to the switch's lever in other than pushing direction.  
ご使用の際、レバーに押し込み方向以外からの外部応力が加わらないように設計して下さい。
- (4) To avoid destruction of a switch. Design and use that the switch's lever is not operated to abnormal direction by the mounting is not in the right place.  
スイッチの破壊を防ぐため、実装ずれによってレバーが特異な方向に操作されないように設計して下さい。

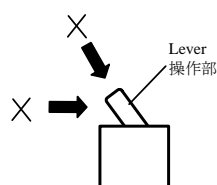

Title 標準書名	COMMON PRODUCT SPECIFICATION FOR INFORMATION 共通納入仕様書	Rule No.11-10 記号番号
Subject 品名	ESE1800Type (1) ESE1800 形 (1)	151-ESE-1800-1 (R 11)

③ Prohibited items and notes on mounting and operating conditions (Continuation)

取付け及び使用条件に関する禁止及び注意事項 (続き)

- (5) To prevent from flux jumping and to ensure proper insulation distance. Design a so set that the gap between the land pattern and the frame exposure part is as wide as possible.  
フラックス上がりの防止、及び、絶縁距離の確保のため、ランドパターンとフレーム露出部の間隔は、できるだけ大きくなるように設計して下さい。
- (6) If multiple switches are placed side by side, or a switch is placed near another part, the gap between the switch and the adjacent switch/part must be at least 1mm to prevent from flux jumping and to ensure proper insulation distance.  
スイッチを並べて、あるいは他の部品と隣接させて使用する場合は、フラックス上がりの防止及び絶縁距離の確保のため、スイッチとの間隔は最低 1 mm 空けてください。
- (7) Design and use so that external stresses is not constantly applied to the soldering parts in a set in any direction. External stress may cause pattern peeling and solder cracks on a PWB.  
セットに取付けた状態で、はんだ付け部に各方向から常時外部応力が加わらないように、設計及び使用上ご配慮ください。プリント配線板のパターンの剥離やはんだにクラックが入る原因となります。
- (8) When mounting a switch (mounting to chassis or button mounting), take care so that no foreign matter enters the switch.  
スイッチを取付けられる際(シャーシへの取付け、ボタン装着時等)、異物がスイッチ内に侵入しないようご注意ください。
- (9) Contact lubricant which is used in detector switches, may flow out to the exterior of the switch due to the structure. For design review, check the operating conditions sufficiently.  
検出スイッチには接点潤滑剤を使用しておりますが、構造上スイッチの外部に潤滑剤が流出する可能性があります。設計検討の際には、使用条件等につきまして十分ご確認・ご配慮ください。
- (10) The switch is not dustproof and not waterproof. Therefore, avoid the following ambient surroundings and other conditions because they may affect performance.  
スイッチは、防塵・防水ではありません。よって、以下の環境及び条件では性能に影響を受けることがありますので、ご使用は避けてください。
- Under an atmosphere of corrosive gas such as Cl<sub>2</sub>, H<sub>2</sub>S, NO<sub>x</sub>, or SO<sub>2</sub>.  
Cl<sub>2</sub>, H<sub>2</sub>S , NO<sub>x</sub> , SO<sub>2</sub> 等の腐食性ガス雰囲気中。
  - In atmospheres of residual water drops, dew condensation, Adhesive water drops.  
水滴残留、結露環境、水滴付着。
  - In liquid such as water, salt solution, oil, chemicals, and organic solvents.  
水、塩水、油、薬品、有機溶剤等の液体中。
  - In direct sunlight.  
直射日光の当たる場所。
  - In dusty locations.  
ほこり、粉塵の多い場所。
- (11) Avoid continuous operation with a switch constantly on NORMAL – CLOSE position.  
常時 ON 状態(押したまま)で連続してのご使用は避けて下さい。
- (12) Avoid continuous operation at temperatures limit of “OPERATING TEMPERATURE”.  
使用温度範囲の限界温度付近で連続してのご使用は避けてください。
- (13) Design so that external stresses is not applied to the switch body when a set is used.  
ご使用の際、スイッチの本体に外部応力が加わらないように設計してください。
- (14) Design so that the operating stroke amount is about 0.5mm longer than full travel of the switch.  
スイッチの押し込み量は、フルストロークに対して 0.5 mm 程度の余裕をもたせるように設計してください。

Title 標準書名	COMMON PRODUCT SPECIFICATION FOR INFORMATION 共通納入仕様書	Rule No.11-11 記号番号
Subject 品名	ESE1800Type (1) ESE1800 形 (1)	151-ESE-1800-1 (R 11)

**④ Prohibited items and notes on storage conditions**

**保管条件に関する禁止及び注意事項**

Since contact characteristics and soldering quality may deteriorate due to sulfuration and oxidation of the contacts and terminals, pay heed to the following items.

接点部や端子部の硫化及び酸化等により、接触特性やはんだ付け性に支障をきたす可能性がありますので以下の事項にご注意ください。

- (1) For storage and transport of the switches, avoid unpacking them, and store them at room temperature and room humidity. Use them as soon as possible, generally within 3 months, or within a maximum of 6 months after delivery.

スイッチの保管又は輸送時には、開梱せずに常温・常湿で保管し、納入後 3 ヶ月を目安とし、6 ヶ月以内を限度として、できるだけ早くご使用ください。

- (2) Do not store the switches under conditions of high temperature and / or high humidity, or in a location where corrosive gas may be generated.

高温多湿の場所及び腐食性ガスの発生する恐れのある場所での保管は避けてください。

- (3) If some units remain after unpacking, keeping them in custody in containers sealed up and applying adequate moisture-proof and gas proof treatment.

開梱後残品のある場合は、密封した容器等に保管し、適切な防湿、防ガス等の処置をしてください。