

ESK, Aluminum Electrolytic, 85C, 2,200 uF, 20%, 25 VDC, -40/+85C, Lead Spacing = 5mm

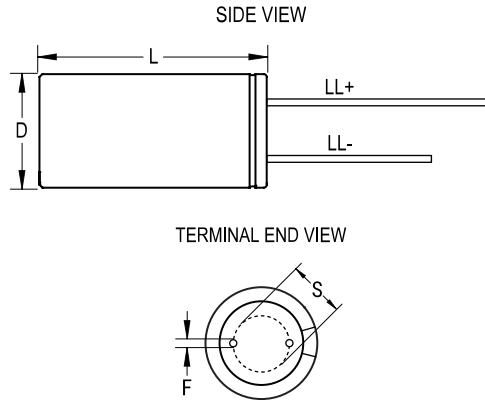

Dimensions	
D	13mm +/-0.5mm
L	25mm +2.0/-0mm
S	5mm +/-0.5mm
LL Negative	15mm MIN
LL Positive	20mm MIN
F	0.6mm NOM

Packaging Specifications	
Packaging:	Bulk, Bag
Packaging Quantity:	1600

General Information	
Supplier:	KEMET
Series:	ESK
Dielectric:	Aluminum Electrolytic
Description:	Single Ended, Aluminum Electrolytic
RoHS:	Yes
Lead:	Wire Leads

Specifications	
Capacitance:	2,200 uF
Capacitance Tolerance:	20%
Voltage DC:	25 VDC, 32 VDC (Surge)
Temperature Range:	-40/+85C
Rated Temperature:	85C
Life:	2000 Hrs
Dissipation Factor:	14.00% 120Hz 20C
Ripple Current:	1300 mAmps (120Hz 85C)
Leakage Current:	550 uA (2min 20C)
Impedance Ratio at -25C:	3
Impedance Ratio at -40C:	4