

Long-life grade capacitors

Applications

- Frequency converters
- Professional switch-mode power supplies

Features

- Long useful life
- High reliability and high ripple current capability
- Small dimensions
- Many different case sizes
- Pinning ensures correct insertion

Construction

- Charge-discharge proof, polar
- Aluminum case, fully insulated
- Overload protection by preset break point in case

Terminals

- 4 snap-in terminals (6,3 mm and 4,5 mm length)
- Solder pin mounting on printed circuit boards, pins fit standardized spacings on PCB

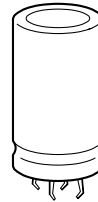

KAL0409-D

B 43 514

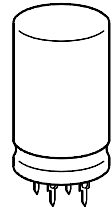

KAL0273-2

B 43 524

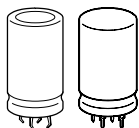
Specifications and characteristics in brief

Rated voltage U_R	350 to 450 VDC	
Surge voltage U_S	$1,1 \cdot U_R$	
Rated capacitance C_R	330 ... 2 200 μF	
Capacitance tolerance	$\pm 20 \% \triangleq \text{M}$	
Leakage current I_L (5 min, 20 °C)	$I_L \leq 0,3 \mu\text{A} \cdot \left(\frac{C_R}{\mu\text{F}} \cdot \frac{U_R}{\text{V}} \right)^{0,7} + 4 \mu\text{A}$	
Self-inductance ESL	Approx. 20 nH	
Useful life 105 °C, U_R ; I_{-R} 40 °C, U_R ; $2,2 \cdot I_{-R}$	> 3 000 h > 200 000 h	Requirements: $\Delta C/C \leq \pm 30 \%$ of initial value $ESR \leq 3$ times initial specified limit $I_L \leq$ initial specified limit Failure percentage: $\leq 1 \%$ Failure rate: ≤ 40 fit ($\leq 40 \cdot 10^{-9}/\text{h}$) (for definiton "fit", refer to chapter "Quality", page 62)
Voltage endurance test 105 °C; U_R	2 000 h	Post test requirements: $\Delta C/C \leq \pm 10 \%$ of initial value $ESR \leq 1,3$ times initial specified limit $I_L \leq$ initial specified limit
Vibration resistance	To IEC 60068-2-6, test Fc: displacement amplitude 0,35 mm, frequency range 10 ... 55 Hz, acceleration max. 5 g, duration 3×2 h	
IEC climatic category	To IEC 60068-1: $U_R \leq 400$ VDC: 40/105/56 (– 40 °C/+ 105 °C/56 days damp heat test) $U_R > 400$ VDC: 25/105/56 (– 25 °C/+ 105 °C/56 days damp heat test)	
Detail specification	Similar to CECC 30301-808	
Sectional specification	IEC 60384-4	

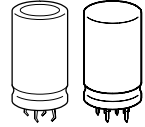

B43514 / B43524

Wide Temperature Range – 105 °C

Dimensional drawings

B43514, 4 snap-in terminals

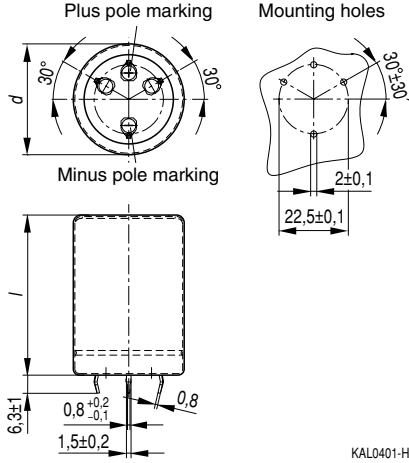

Standard snap-in terminals: length $(6,3 \pm 1)$ mm.
Also available with a length of $(4,5 - 1)$ mm.
For ordering example cf. page 200

Dimensions (mm)			Approx. weight (g)	Packing units (pieces)
$d + 1$	$l \pm 2$	l_{max}		
35	50	54	63	60
35	60	64	76	36
35	70	74	88	36
35	80	84	101	36
35	100	104	126	36
40	40	44	71	33
40	50	54	89	33
40	60	64	107	33
40	70	74	125	33
40	80	84	143	33
40	100	104	178	33
45	40	—	90	28
45	50	—	113	28
45	60	—	136	28
45	70	—	158	28
45	80	—	181	28
45	100	—	226	28

B43524, solder pins

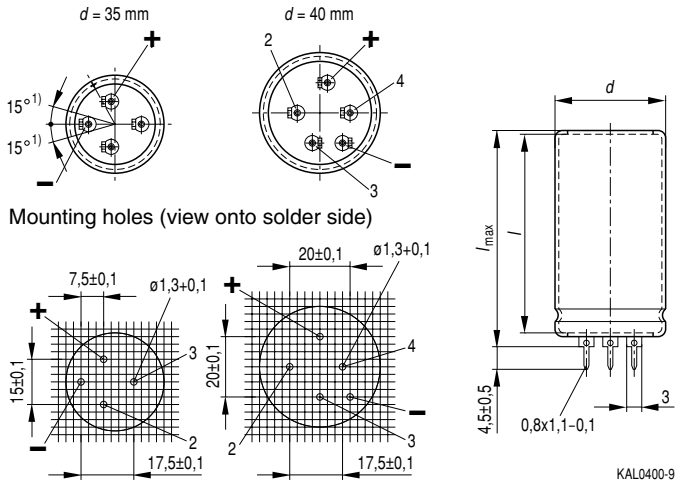

- 1) Permissible range of positions for pole identification marks

Pole markings: Plus: **+**; Minus: **-**

All pin holes must be drilled into the PC-board, since the unconnected pins serve as mountings. These pins must be soldered to isolated pads or pads with the same potential as the negative pole (solder pin and 4 snap-in terminals).

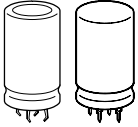

B43514 / B43524

Wide Temperature Range – 105 °C

Packing of 4 snap-in terminals and solder pins



For ecological reasons the packing is pure cardboard.

Ordering codes

4 snap-in terminals Version	Identification in 3rd block of ordering code
Standard terminals (6,3 ± 1) mm	M000
Short terminals (4,5 – 1) mm	M007

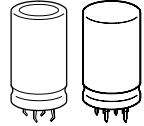

Overview of available types

U_R (VDC)	350	400	420	450
C_R (μ F)	Case dimensions $d \times l$ (mm)			
330				35 × 50 40 × 40
390		35 × 50	35 × 50 40 × 40	35 × 60 40 × 50
470	35 × 50	35 × 60 40 × 50 45 × 40	35 × 60 40 × 50	35 × 70 40 × 60 45 × 50
560	35 × 60 40 × 50	35 × 70 40 × 50	35 × 70 40 × 50	35 × 80 40 × 60 45 × 50
680	35 × 70 40 × 50	35 × 80 40 × 60 45 × 50	35 × 80 40 × 60 45 × 50	40 × 70 45 × 60
820	35 × 80 40 × 60	40 × 70 45 × 60	40 × 70 45 × 60	
1 000	40 × 70 45 × 60	35 × 100 40 × 80 45 × 70	40 × 80 45 × 70	40 × 100 45 × 80
1 200				45 × 100
1 500	40 × 100 45 × 80	45 × 100	45 × 100	
2 200	45 × 100			

The capacitance and voltage ratings listed above are available in different cases upon request.

Other voltage and capacitance ratings are also available upon request.

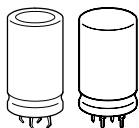
Capacitors with solder pins are only available in 35 and 40 mm case diameters.



Technical data and ordering codes

U_R	C_R 100 Hz 20 °C VDC μF	Case dimensions $d \times l$ mm	ESR_{max} 100 Hz 20 °C m Ω	Z_{max} 10 kHz 20 °C m Ω	I_{max} 100 Hz 40 °C A	I_{max} 100 Hz 85 °C A	I_{R} 100 Hz 105 °C A	Ordering code ¹⁾ * 1 = 4 snap-in 2 = solder pin
350	470	35 × 50	280	220	6,7	4,4	2,2	B435*4A4477M000
	560	35 × 60	230	190	7,8	5,1	2,6	B435*4A4567M000
	560	40 × 50	230	190	7,7	5,1	2,5	B435*4C4567M000
	680	35 × 70	190	150	8,6	5,6	2,8	B435*4A4687M000
	680	40 × 50	190	150	7,9	5,2	2,6	B435*4C4687M000
	820	35 × 80	160	130	9,9	6,5	3,3	B435*4A4827M000
	820	40 × 60	160	130	9,3	6,1	3,1	B435*4C4827M000
	1 000	40 × 70	130	110	11	7,2	3,6	B435*4A4108M000
	1 000	45 × 60	130	110	10	6,8	3,4	B43514C4108M000
	1 500	40 × 100	90	70	15	10	5,1	B435*4A4158M000
	1 500	45 × 80	90	70	14	9,2	4,6	B43514C4158M000
	2 200	45 × 100	60	50	19	12	6,1	B43514A4228M000
400	390	35 × 50	330	270	6,1	4,0	2,0	B435*4A9397M000
	470	35 × 60	280	220	7,2	4,7	2,4	B435*4A9477M000
	470	40 × 50	280	220	7,1	4,6	2,3	B435*4C9477M000
	470	45 × 40	280	220	6,6	4,3	2,2	B43514E9477M000
	560	35 × 70	230	190	7,8	5,1	2,6	B435*4A9567M000
	560	40 × 50	230	190	7,2	4,7	2,4	B435*4C9567M000
	680	35 × 80	190	150	9,0	5,9	3,0	B435*4A9687M000
	680	40 × 60	190	150	8,5	5,6	2,8	B435*4C9687M000
	680	45 × 50	190	150	8,0	5,2	2,6	B43514E9687M000
	820	40 × 70	160	130	9,9	6,5	3,2	B435*4A9827M000
	820	45 × 60	160	130	9,3	6,1	3,1	B43514C9827M000
	1 000	35 × 100	130	110	12	7,9	4,0	B435*4A9108M000
	1 000	40 × 80	130	110	12	7,5	3,8	B435*4C9108M000
	1 000	45 × 70	130	110	11	7,2	3,6	B43514E9108M000
	1 500	45 × 100	90	70	15	10	5,1	B43514A9158M000

Capacitors with solder pins are only available in 35 and 40 mm case diameters.

Preferred types

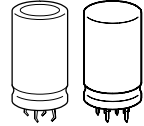
1) For capacitors with short 4 snap-in terminals, see page 200.



U_R	C_R 100 Hz 20 °C	Case dimensions $d \times l$ mm	ESR_{max} 100 Hz 20 °C mΩ	Z_{max} 10 kHz 20 °C mΩ	$I_{~max}$ 100 Hz 40 °C A	$I_{~max}$ 100 Hz 85 °C A	$I_{~R}$ 100 Hz 105 °C A	Ordering code ¹⁾ * 1 = 4 snap-in 2 = solder pin
VDC	μF							
420	390	35 × 50	520	410	6,1	4,0	2,0	B435*4A0397M000
	390	40 × 40	520	410	6,0	3,9	1,9	B435*4C0397M000
	470	35 × 60	430	340	7,2	4,7	2,3	B435*4A0477M000
	470	40 × 50	430	340	7,1	4,6	2,3	B435*4C0477M000
	560	35 × 70	360	290	7,8	5,1	2,5	B435*4A0567M000
	560	40 × 50	360	290	7,2	4,7	2,4	B435*4C0567M000
	680	35 × 80	300	240	9,0	5,9	3,0	B435*4A0687M000
	680	40 × 60	300	240	8,5	5,6	2,8	B435*4C0687M000
	680	45 × 50	300	240	8,0	5,2	2,6	B43514E0687M000
	820	40 × 70	250	200	9,9	6,5	3,2	B435*4A0827M000
	820	45 × 60	250	200	9,3	6,1	3,1	B43514C0827M000
	1 000	40 × 80	200	160	11	7,5	3,8	B435*4A0108M000
	1 000	45 × 70	200	160	10	7,2	3,6	B43514C0108M000
	1 000	45 × 100	140	110	15	10	5,0	B43514A0158M000
450	330	35 × 50	610	490	5,6	3,7	1,8	B435*4A5337M000
	330	40 × 40	610	490	5,5	3,6	1,8	B435*4C5337M000
	390	35 × 60	520	410	6,5	4,3	2,1	B435*4A5397M000
	390	40 × 50	520	410	6,4	4,2	2,1	B435*4C5397M000
	470	35 × 70	430	340	7,1	4,7	2,3	B435*4A5477M000
	470	40 × 60	430	340	7,1	4,6	2,3	B435*4C5477M000
	470	45 × 50	430	340	6,6	4,4	2,2	B43514E5477M000
	560	35 × 80	360	290	8,2	5,4	2,7	B435*4A5567M000
	560	40 × 60	360	290	7,7	5,1	2,5	B435*4C5567M000
	560	45 × 50	360	290	7,2	4,7	2,4	B43514E5567M000
	680	40 × 70	300	240	9,0	5,9	3,0	B435*4A5687M000
	680	45 × 60	300	240	8,5	5,6	2,8	B43514C5687M000
	1 000	40 × 100	200	160	13	8,3	4,1	B435*4A5108M000
	1 000	45 × 80	200	160	11	7,5	3,8	B43514C5108M000
1 200	45 × 100	170	140	14	9,0	4,5	B43514A5128M000	

Capacitors with solder pins are only available in 35 and 40 mm case diameters.

Preferred types

1) For capacitors with short 4 snap-in terminals, see page 200.

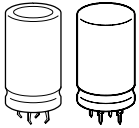

Useful life

depending on ambient temperature T_A under ripple current operating conditions ¹⁾

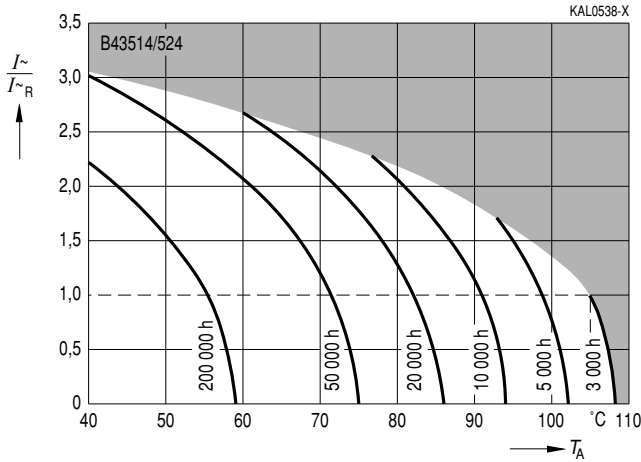

Frequency factor of permissible ripple current I_{\sim} versus frequency f

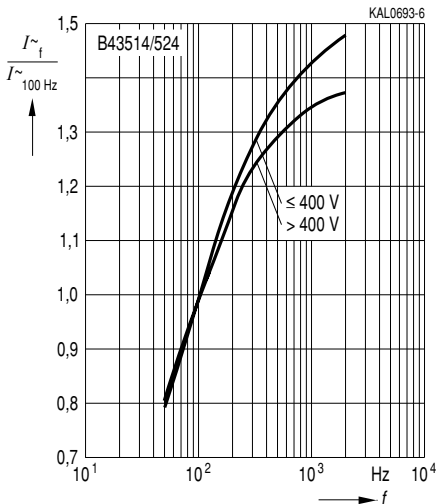

Frequency characteristics of ESR
Typical behavior

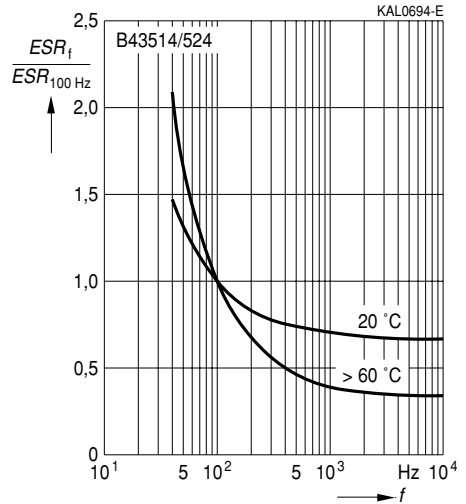

1) Refer to page 40 for an explanation on how to interpret the useful life graphs.

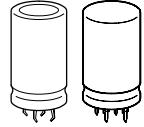

Impedance Z at $f = 10$ kHz
 versus frequency f
 Typical behavior at 20 °C

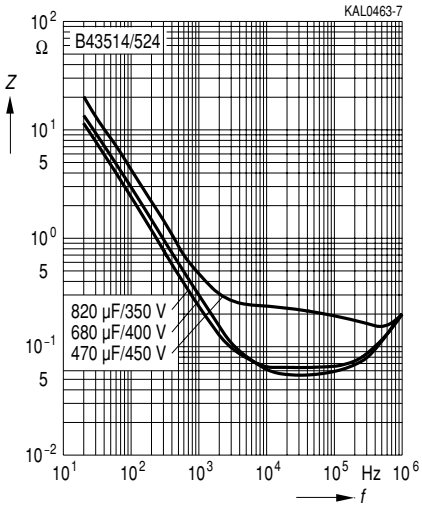

Herausgegeben von EPCOS AG

Unternehmenskommunikation, Postfach 80 17 09, 81617 München, DEUTSCHLAND

☎ ++49 89 636 09, FAX (0 89) 636-2 26 89

© EPCOS AG 2002. Vervielfältigung, Veröffentlichung, Verbreitung und Verwertung dieser Broschüre und ihres Inhalts ohne ausdrückliche Genehmigung der EPCOS AG nicht gestattet.

Bestellungen unterliegen den vom ZVEI empfohlenen Allgemeinen Lieferbedingungen für Erzeugnisse und Leistungen der Elektroindustrie, soweit nichts anderes vereinbart wird.

Diese Broschüre ersetzt die vorige Ausgabe.

Fragen über Technik, Preise und Liefermöglichkeiten richten Sie bitte an den Ihnen nächstgelegenen Vertrieb der EPCOS AG oder an unsere Vertriebsgesellschaften im Ausland. Bauelemente können aufgrund technischer Erfordernisse Gefahrstoffe enthalten. Auskünfte darüber bitten wir unter Angabe des betreffenden Typs ebenfalls über die zuständige Vertriebsgesellschaft einzuholen.

Published by EPCOS AG

Corporate Communications, P.O. Box 80 17 09, 81617 Munich, GERMANY

☎ ++49 89 636 09, FAX (0 89) 636-2 26 89

© EPCOS AG 2002. Reproduction, publication and dissemination of this brochure and the information contained therein without EPCOS' prior express consent is prohibited.

Purchase orders are subject to the General Conditions for the Supply of Products and Services of the Electrical and Electronics Industry recommended by the ZVEI (German Electrical and Electronic Manufacturers' Association), unless otherwise agreed.

This brochure replaces the previous edition.

For questions on technology, prices and delivery please contact the Sales Offices of EPCOS AG or the international Representatives.

Due to technical requirements components may contain dangerous substances. For information on the type in question please also contact one of our Sales Offices.