

## DESCRIPTION

Demonstration board DC093A is a complete DC/DC step-up switching regulator using the LT<sup>®</sup>1371 constant frequency, high efficiency converter in a 7-pin DD package.

High frequency switching allows the use of small inductors, making this all surface mount solution ideal for space conscious systems.

LT, LTC and LT are registered trademarks of Linear Technology Corporation.

## PERFORMANCE SUMMARY T<sub>A</sub> = 25°C, V<sub>IN</sub> = 5V, S/S pin open, unless otherwise specified.

PARAMETER	CONDITIONS	MIN	TYP	MAX	UNITS
Output Voltage	R2 = R3 = 1% (Note 1)	11.60	12.04	12.50	V
Output Current	V <sub>IN</sub> = 5V	800			mA
Input Voltage Range	(Note 2)	2.7		11	V
Switching Frequency			500		kHz
Output Ripple Voltage	I <sub>LOAD</sub> = 800mA		140		mV <sub>P-P</sub>
Supply Current	I <sub>LOAD</sub> = 0A		5		mA
Shutdown Supply Current	I <sub>LOAD</sub> = 0A, V <sub>S/S</sub> = 0V (Note 3)		100		μA

**Note 1:** The reference voltage tolerance of the LT1371 is ±1.6% over temperature. Output voltage is a worst-case summation of R2, R3 and reference tolerances, plus feedback input current times R3. For a tighter output voltage range, use lower tolerance feedback resistors, or a fixed voltage version of the LT1371 (consult Linear Technology Marketing).

**Note 2:** Increase L1 to 15μH for V<sub>IN</sub> < 3.3V.

**Note 3:** Single inductor step-up converters have a direct path from the input supply to the output, and therefore draw some supply current even when the LT1371 is in shutdown. Shutdown supply current will also increase with the addition of an output load. Applications are available that remove this direct path and reduce shutdown supply current to 30μA maximum, independent of loading.

## TYPICAL PERFORMANCE CHARACTERISTICS AND BOARD PHOTO

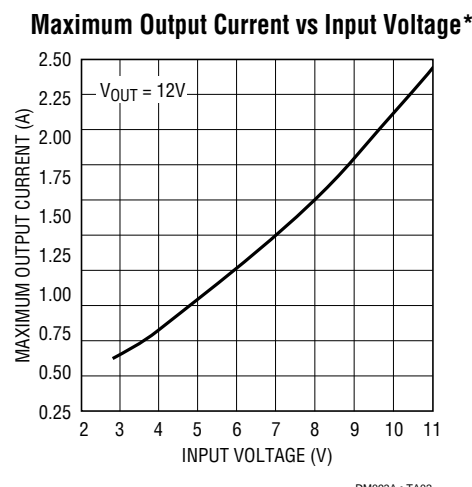
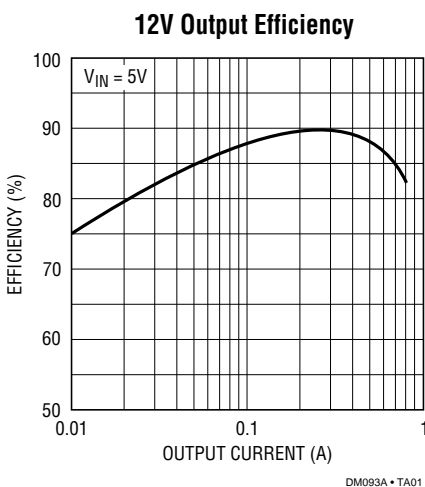

\*INCREASE L1 TO 15μH FOR V<sub>IN</sub> < 3.3V



PACKAGE A ID SCHEMATIC DIAGRAMS

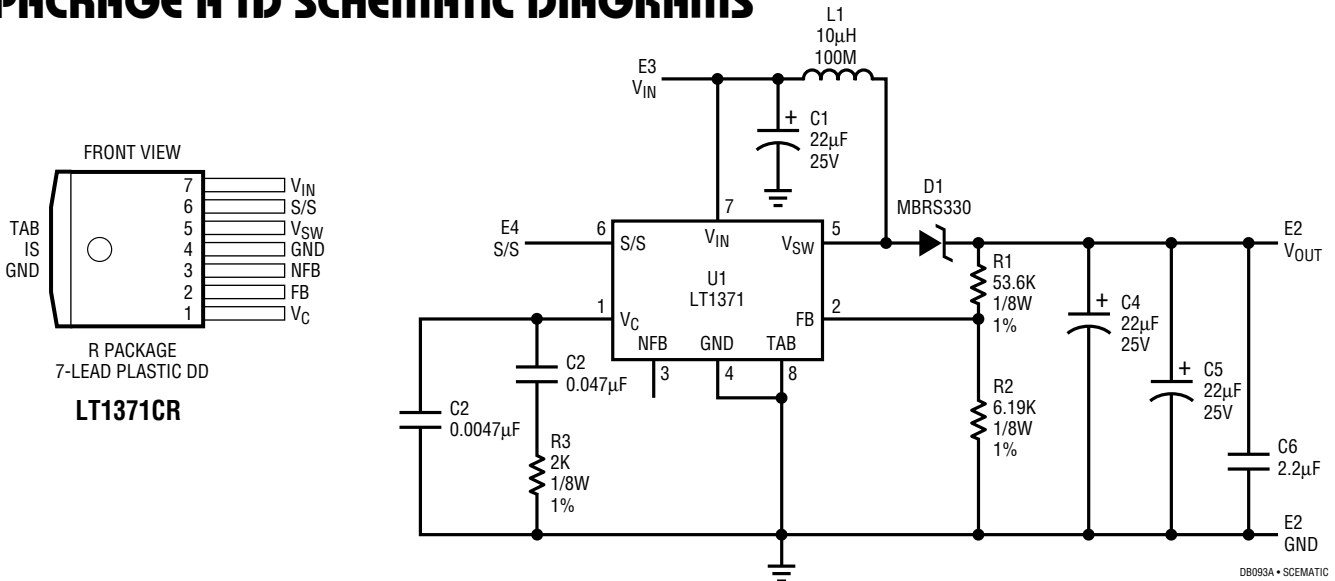

Figure 1. Switching Regulator 5V to 12V, 0.25A

PARTS LIST

REFERENCE DESIGNATOR	QUANTITY	PART NUMBER	DESCRIPTION	VENDOR	TELEPHONE
C1, C4, C5	3	TPSD226M025R0200	22µF, 25V, 20%, Tantalum Capacitor	AVX	(803) 448-9411
C2	1	08055G473MATIA	0.047µF, 50V, 20%,Capacitor	AVX	
C3	1	08055G472MATIA	0.0047µF, 50V, 20%, Capacitor	AVX	
C6	1	1206YG225ZATMAM	2.2µF, 16V, 20%, Capacitor	AVX	
D1	1	MBRS330T3	MBRS330, Diode	Motorola	(602) 244-5768
E1, E2, E3, E4, E5	4	1502-2	Turret	Keystone	(718) 950-8900
L1	1	CD104-100MC	10µH, Inductor	Sumida	(708) 956-0666
R1	1	CR215362FT	53.6k, 1/8W, 1%, Resistor	AVX	
R2	1	CR216191FT	6.19k, 1/8W, 1%, Resistor	AVX	
R3	1	CR212001FT	2k, 1/8W, 1%, Resistor	AVX	
U1	1	LT1371CR	Switching Regulator IC	LTC	(408) 432-1900
	1	216-40CT	Heat Sink, Optional	Wakefield Eng.	(617) 245-5900

OPERATION

DC093A Operation

This DC093A demonstration board is intended for evaluating the LT1371 switching regulator in a typical step-up application. Solid turret terminals are provided for easy connection to test equipment. A device pinout and board schematic are shown in Figure 1. Please refer to the LT1371 data sheet for additional specifications and applications information. You may find Linear Technology’s SwitcherCAD software helpful for creating your own designs.

Hook-Up

Connect the input supply and measurement instruments to the VIN and GND terminals. The S/S pin (synchronization/shutdown) can be connected to VIN or left open. Connect the output load and measurement instruments to the VOUT and GND terminals.

## OPERATION

### LT1371 Operation

The LT1371 is a monolithic, high frequency, current mode switcher. The part can operate from an input supply range of 2.7V to 25V (DC093A maximum  $V_{IN} = 11V$ ) and draws only 4mA quiescent current. The on-chip current limited power switch is guaranteed to 3A minimum switch current with a 0.25 $\Omega$  typical “on” resistance and a 35V minimum breakdown voltage. Operating at a fixed frequency of 500kHz, switching can also be easily synchronized to a higher frequency by driving the S/S pin with a logic level source. Shutdown is activated by pulling the S/S pin below 0.6V, which reduces device supply current to 30 $\mu$ A maximum.

Under normal operating conditions, a 1.245V reference voltage is developed at the Feedback pin. The output voltage is set by R2 and R3, where  $V_{OUT} = V_{REF}(1 + R3/R2)$ . Although not used in this application, the part also has a Negative Feedback pin (NFB) which can be used to set the output voltage of positive-to-negative converters. When in use, a -2.49V reference voltage is developed at the NFB pin.

The  $V_C$  pin is the output of the error amplifier. During normal regulator operation this pin sits at a voltage between 1V (low output current) and 1.9V (high output current). Loop frequency compensation is also performed at the  $V_C$  pin via an RC network to ground.

## COMPONENTS

### Inductors

The inductor is a Sumida CD104-100MC, a 10 $\mu$ H unshielded ferrite unit. It was selected for low cost and small physical size. Similar units are available from other manufacturers. An inductor with a closed magnetic path (i.e., an E-core or toroid) may also be chosen to reduce the RFI/EMI of the circuit.

### Capacitors (and Input/Output Ripple Voltage)

The capacitors on this board are low ESR (Effective Series Resistance) tantalum units specifically designed for switch-mode power supply applications. At these high frequencies, input and output ripple voltages are more a function of the ESR of the capacitor than of the capacitance value. For example, at 500kHz a 22 $\mu$ F capacitor has a capacitive

reactance of only 0.014 $\Omega$ , which is much lower than the limiting 0.2 $\Omega$  maximum ESR of the capacitors used. Therefore, if a reduction in input or output ripple voltage is required, use two or more capacitors in parallel instead of a larger value capacitor. If very low output ripple voltage is needed, adding an output LC filter may be a cheaper solution. The output contains very narrow voltage spikes because of the parasitic inductance of the output capacitor. Due to their high frequency nature, the amplitude of the spikes is determined by the ESL (Effective Series Inductance) of the output capacitor. But this also makes them easy to filter. Small 0.1 $\mu$ F ceramic chip capacitors work well in reducing the spikes, and if the traces connecting to the load are a few inches or more, the parasitic inductance of the traces combined with any local load bypass capacitor will virtually eliminate the spikes at the load.

### Diodes

Use diodes designed for switching applications with adequate current rating and fast turn-on times, such as Schottky or ultra-fast diodes. In selecting a diode, the basic parameters of interest are forward voltage, maximum reverse voltage, average operating current and peak current. Lower forward voltage yields higher circuit efficiency and lower power dissipation in the diode. The worst-case reverse voltage is equal to the output voltage. The average diode current will be equal to the output current, but the peak diode current can be many times higher than the output current. Except for output short conditions, peak diode current is limited to the switch current limit of 4.8A maximum.

### Thermal Considerations

Care should be taken to ensure that the worst-case input voltage and load current conditions do not cause excessive die temperatures. Please consult the LT1371 data sheet or Linear Technology’s SwitcherCAD software for more information.

### PCB Layout

In many cases, the circuit area traces of the demonstration board may be dropped directly into your PCB layout. If not, there are a few things to be aware of with high frequency converter layouts. Keep the traces connecting the Switch

# DEMO MANUAL DC093

## OPERATION

(Pin 5), output diode, output capacitor and ground return path (Pin 4 and Tab) as short as possible. This will reduce RFI and limit the voltage spikes caused by parasitic induc-

tance. Keep the more sensitive components, mainly the feedback resistors and  $V_C$  pin network, away from the high current switching components.

## PCB LAYOUT AND FILM

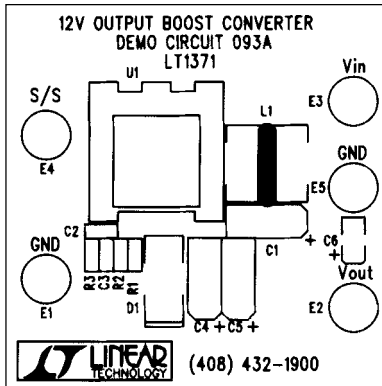

Silkscreen Top

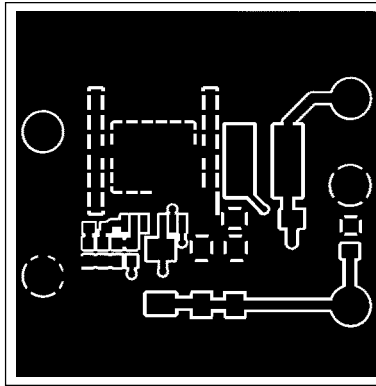

Component Side

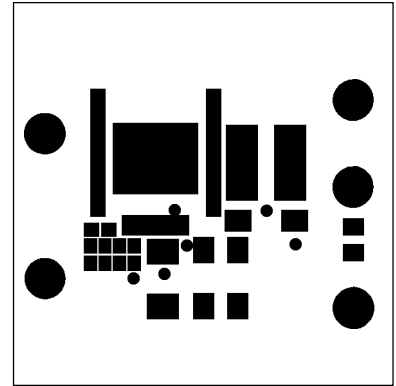

Solder Mask Top

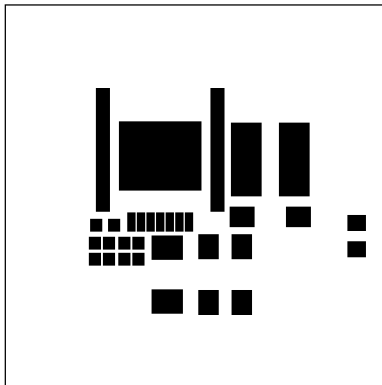

Paste Mask Top

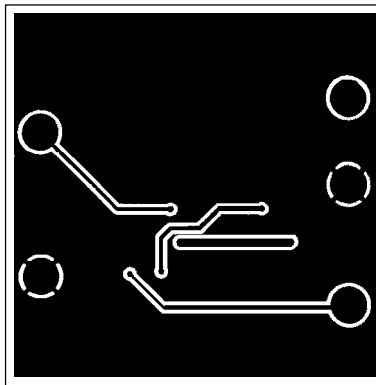

Solder Side

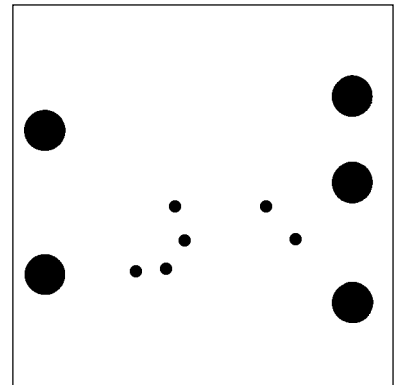

Solder Mask Bottom

## PC FAB DRAWING

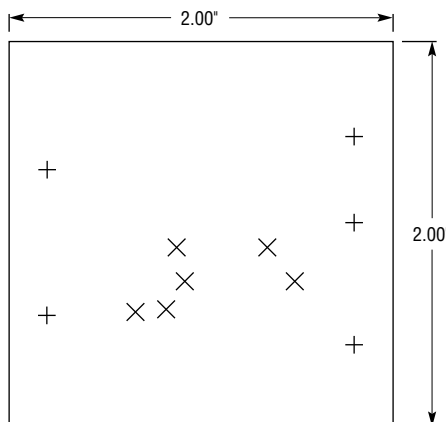

NOTES: UNLESS OTHERWISE SPECIFIED

1. MATERIAL: FR4 OR EQUIVALENT EPOXY, 2 OZ COPPER CLAD THICKNESS 0.062" ±0.006 TOTAL OF 2 LAYERS
2. FINISH:
  - A. ALL PLATED HOLES 0.001" MIN/0.0015" MAX COPPER PLATE
  - B. ELECTRODEPOSITED TIN-LEAD COMPOSITION. BEFORE REFLOW, SOLDER MASK OVER BARE COPPER (SMOBC)
  - C. SOLDER MASK: BOTH SIDES USING GREEN PC-401 OR EQUIVALENT
  - D. SILKSCREEN: USING WHITE NONCONDUCTIVE EPOXY INK
3. LAYER SEQUENCE: COMPONENT SIDE = LAYER 1  
SOLDER SIDE = LAYER 2

SYMBOL	DIAMETER	# OF HOLES
X	0.025	6
+	0.095	5
TOTAL HOLES		11