



S040W-056C1500

40W Programmable LED Drivers



Electrical Specifications

Maximum Power:	40W
Typical Efficiency:	84%
Input Voltage Range:	120-277 Vac Nom. (108-305 V Min/Max)
Frequency:	50/60 Hz Nom. (47-63 Hz Min/Max)
Power Factor:	≥ 0.90 @ ≥ 60% Full Load, 120Vac-277Vac
Inrush Current:	<14A@120Vac, < 30.0A @ 277Vac
Input Current (Max):	0.41 Amps @ 120 Vac, 0.19 Amps @ 277 Vac
Output Dimming Range:	0-100% with adjustable minimum
Load Regulation:	±3%
Line Regulation:	±2%
THD:	≤ 20% @ ≥ 60% full load
Start-up Time:	<750ms @ 100% Load
Output Ripple Current:	5% Io

Protections

Over-voltage:	Auto recovery
Over-current:	Auto recovery, Current limiting circuit
Short Circuit:	Auto recovery
Over-temperature:	Auto recovery

Environmental Specifications

Max Case Life Temp: (5 year warranty)	85°C
Maximum Case Temp (UL):	85°C
Minimum Starting Temp:	-30°C
Storage Temperature:	-40°C to +100 °C
Humidity:	Up to 90% RH
Cooling:	Convection
Vibration Frequency:	5 to 55 Hz/2g, 30 minutes
Sound Rating:	Class A
EMC:	FCC 47CFR Part 15 Class A compliant
Weight:	8.0 oz. (226.8 grams)



- Program driver with GUI software for fast setup
- Option to program output current with Rset resistor
- Linear or logarithmic dimming curve options
- Flicker free output for comfort and critical applications
- 2-stage power supply design for better performance over wide range of outputs
- Auxiliary 12Vdc, 200mA output for powering controls or fans
- NTC option allows for thermal protection of LED engine
- Programmable Output Current (POC): 300-1500mA
- UL Class P, Class 2, Dry & Damp Location Rated
- Dim to zero with 0-10V dimming
- Metal housing
- 5 year warranty*

* For extended warranty options beyond 5 yrs., contact factory.

Part	Model	Adj. Current Out (mA ±5%)	Voltage Out (Vdc)	Max Power (W)	Wire Entry
93057519	S040W-056C1500-C01-UN-D2	300-1500	12-56	40	Bottom
93057520	S040W-056C1500-C02-UN-D2	300-1500	12-56	40	Dual

Class 2: US/Canada

Safety Cert.	Standard
UL/CUL	UL8750, UL1310 for UL Class 2 & CAN/CSA C22.2 No. 250.13, UL Class P
CE	EN61347-1, EN61347-2-13
EMC Standard	Notes
FCC, 47CFR Part 15	Class A
EN 55015	Limits and methods of measurement of radio disturbance characteristics of electrical lighting and similar equipment.
EN 61000-3-2	Part 3-2: Limits for harmonic current emissions Class C, ≥80% Rated Power
EN 61000-3-3	Part 3-3: Limitation of voltage changes, voltage fluctuations and flicker
EN 61000-4-5	Part 4-5: Surge Immunity test, 2 kV L-N, 4 kV L-FG & N-FG
Energy Star	Energy Star transient protection: Ballast or driver shall comply with ANSI/IEEE C62.41.1-2002 and ANSI/IEEE C62.41.2-2002, Category A operation. The line transient shall consist of seven strikes of a 100 kHz ring wave, 2.5 kV level, for both common mode and differential mode.



Dimensions

C01: Bottom Entry Case Configuration

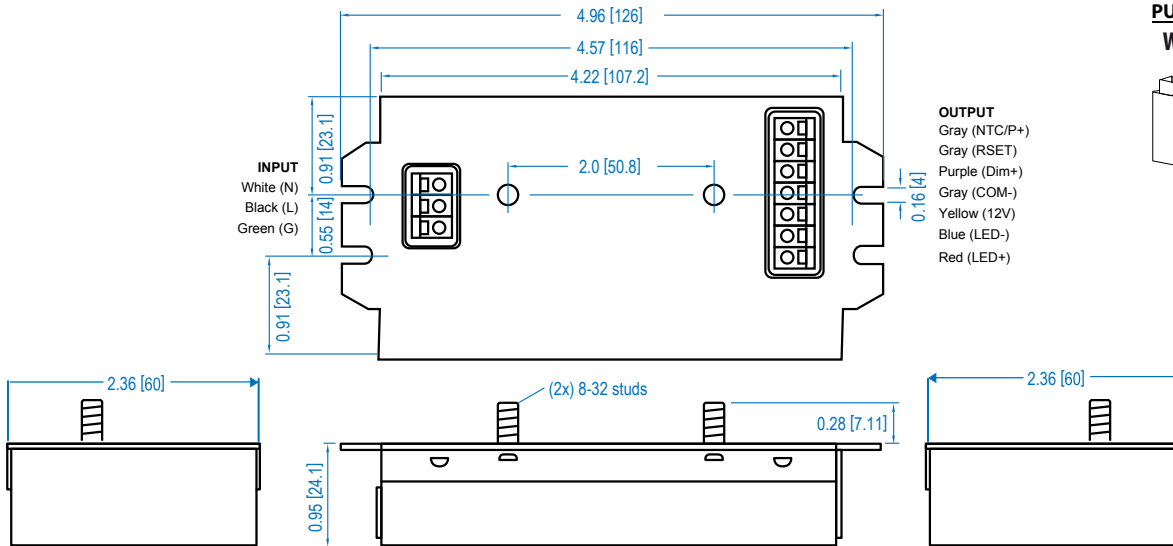

C02: Dual Entry Case Configuration

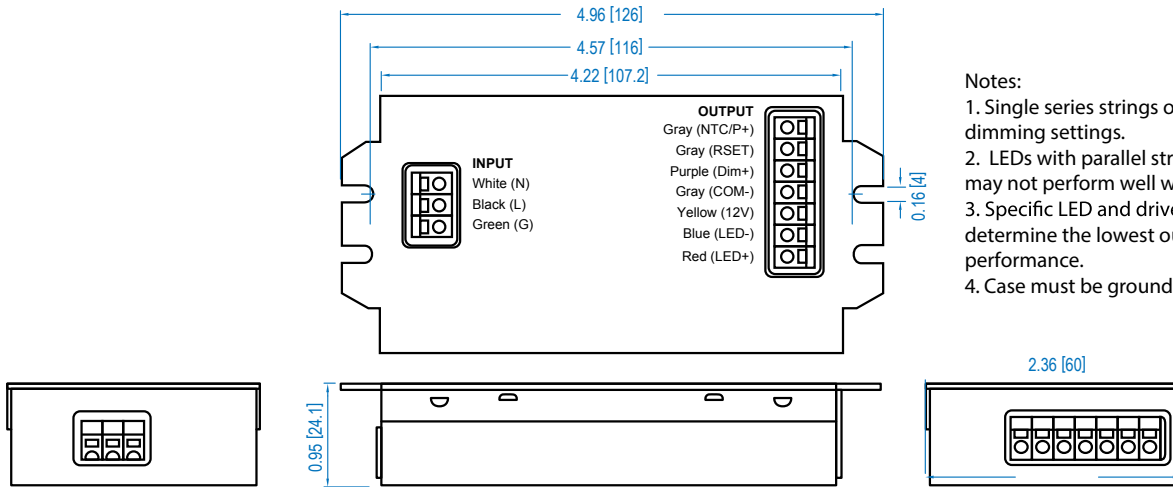

C01 & C02 Hot Spot Location

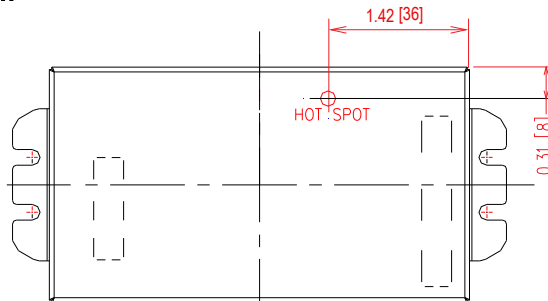

LED Light Engine Remote Mounting

Recommended maximum wiring distance at full load.

AWG	#22	#21	#20	#19	#18
Distance (m)	10	12	14	18	22
Distance (ft)	32.8	39.4	45.9	59	72.2

Power Characteristics

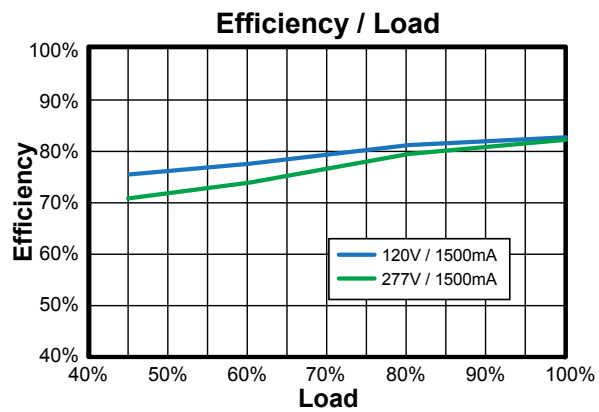
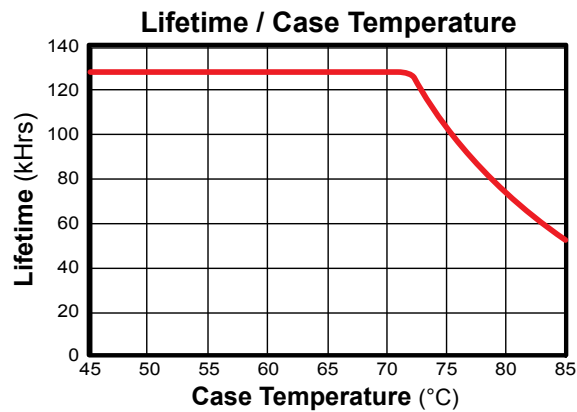
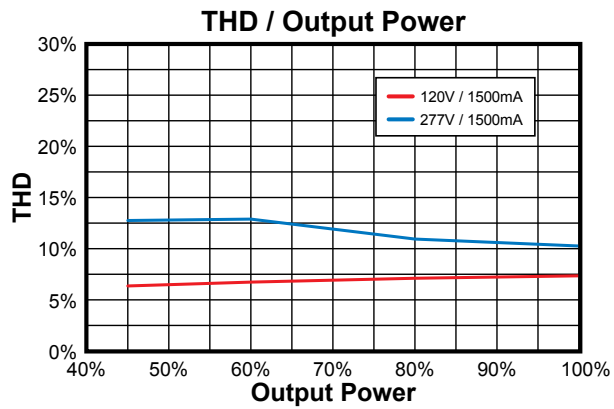
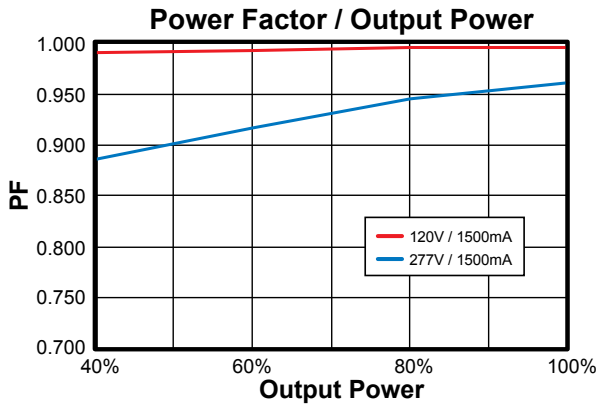

Parameter Defaults

Parameter	Default Setting	Setting Range	Increment
Output Current (mA)	700	300 - 1500	1
Enable Analog Dimming	Yes	Yes or No	
Analog Dimming Low Level (%)	1	0 - 100	1
Dimming Curve	Linear	Linear or Logarithmic	
NTC-Derating Temperature Start (kΩ)	6.3	1 - 7.5	0.01
NTC-Derating Temperature End (kΩ)	2	1 - 5.5	0.01
NTC-Minimum Output Level (%)	100	1 - 100	1

Note: The area under the life-temperature curve represents where the driver has highly reliable operation within specification. Driver performance may drift out of published specifications as the hours of operation exceed the curve at a given temperature. Higher operating temperatures increase the chances of a failure to function. Other electrical, mechanical and environmental factors affect driver lifetime but are not represented in this calculation.

Wiring

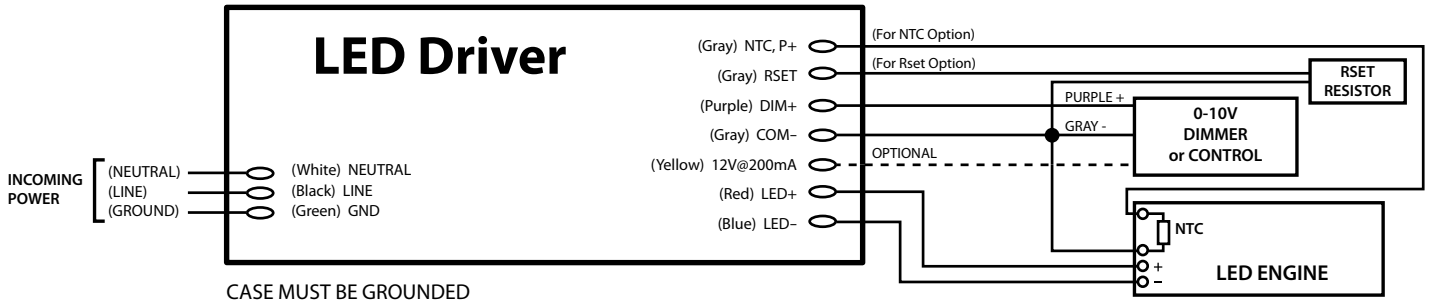

Power Operating Window

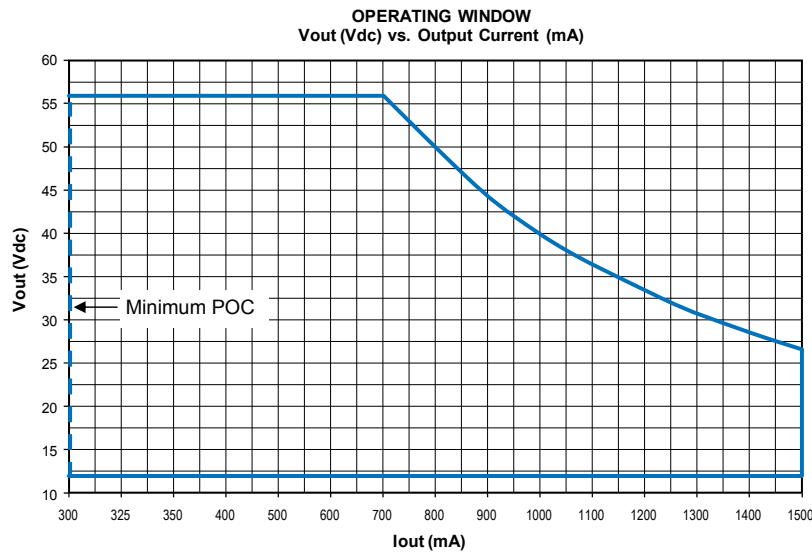

Labeling Programmable Drivers

It is highly recommended that the drivers be labeled with information traceable to the programming profile. It can include the programmed output current, dimming curve type, minimum dimming level and name of the file storing the profile.

This information is critical to answering any field questions from the contractor or end user.

Programming Guide

Refer to the SelectSYNC Programming Software User's Manual.

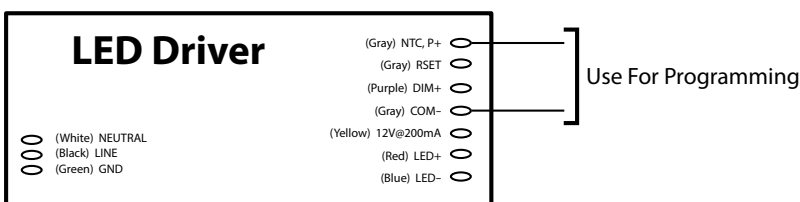

Dimming: 0-10Vdc

Parameters	Minimum	Typical	Maximum
12V Auxiliary Output	11.0V	12.0V	13.0V
12V Auxiliary Output Source Current	0mA	—	200mA
Absolute Voltage Range on 0-10V Input (Purple Wire)	-2.0V	—	+15V
Source Current out of 0-10V Input (Purple Wire)	0mA	—	1.5 mA

Typical Dimming Circuit: 2-Wire Resistance

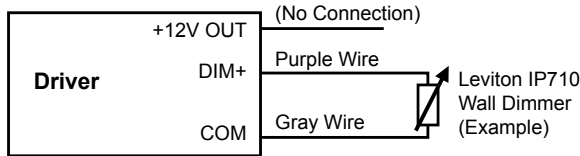

Typical Dimming Circuit: 2-Wire 0-10V Analog

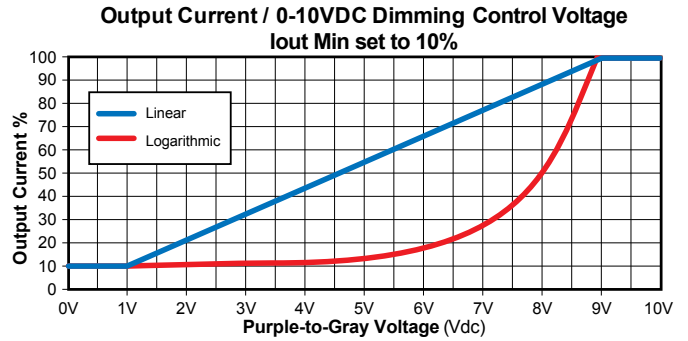
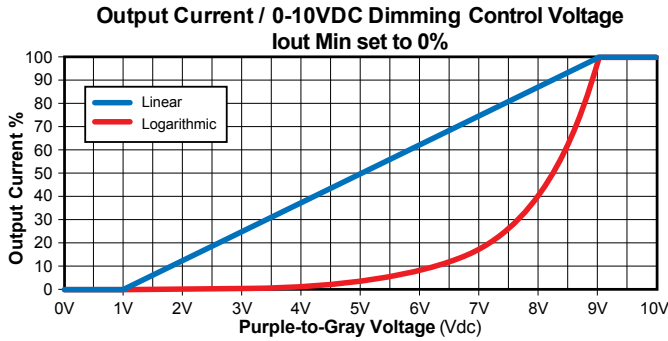
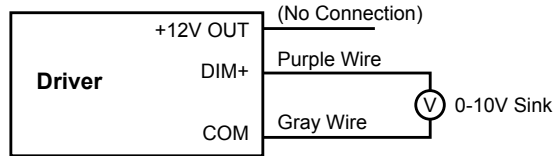

0-10V Dimming Notes:

1. Part comes with DIM+, COM & +12V auxiliary connectors. DIM+ and +12V return are connected to COM. This is for controls and sensors that need a 12V supply.
2. Part is compatible with most 0-10V Wall Slide dimmers and direct 0-10V analog signal. Recommended dimmer is Leviton IP710 or equivalent connected between DIM + and COM wires.
3. Output current will be Minimum Programmed Value when $V_{dim} \leq 1.00V$. If set to 0% then this indicates dim to zero operation.
4. Output will be 100% with DIM+/COM open or above 9.0V and Minimum Programmed Value with DIM+/COM Shorted.
5. Minimum dimming level is programmable with TRP Programming software.

NTC Information

Module Temperature Protection using External NTC (Negative Temperature Coefficient)

Select a Negative Thermal Coefficient (NTC) resistor with a resistance range that allows the full output current to flow at safe LED operating temperatures. NTC resistance should drop sufficiently to allow reduced output current at elevated or harmful LED temperature levels. NTC operation should be thoroughly tested to ensure proper operation over all the full temperature range of the Driver and the LED Engine.

Example: NTC High, NTC Low and NTC Minimum Iout% can be programmed using TRP Programmer USB interface & TRP PC based GUI Software.
 Factory Default Settings: NTC Low = 2.0K \approx 10% Iout, NTC High = 6.3K, 100% Iout
 Programmable settings: NTC Minimum Level (%), NTC Minimum Ohms, NTC Maximum Ohms.

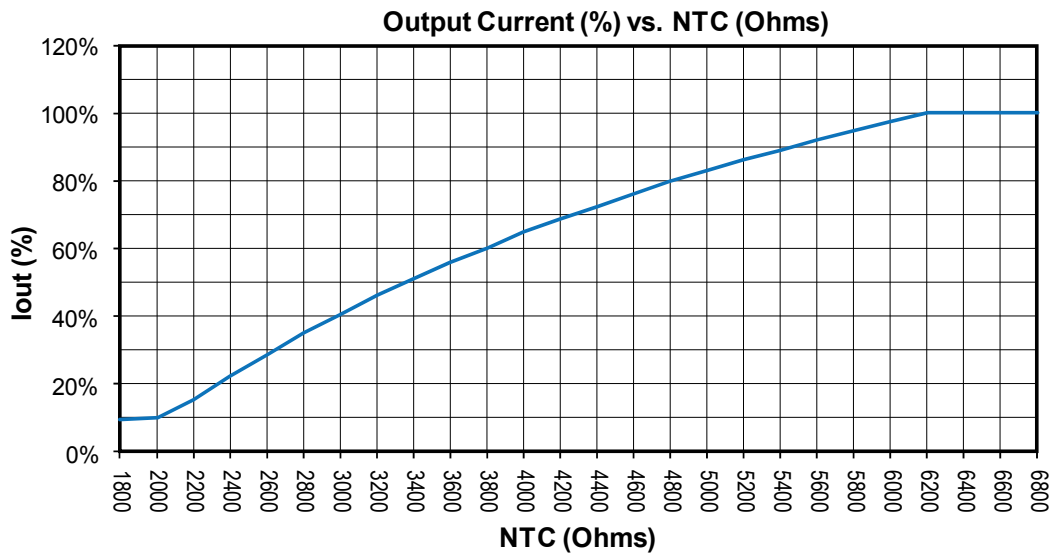

Module Temperature Protection Example

NTC = 805SMD, $R_{25C} = 15K \text{ Ohm} \pm 2\%$, $R_{64C} = 3700$, Vishay Part #: NTCS0805E3153GMT
 With part set: NTC Max = 6.3K, NTC MIN = 2.0K, Iout Min = 10%

