

Sensorless Motor Drive Platform for Appliance Based on iMOTION™ Chipset

Features

- IRMCF341 - iMOTION™ digital control IC - based system
- MCE™ (Motion Control Engine) - Hardware based computation engine for high efficiency sinusoidal sensorless control of Permanent Magnet motors
- Supports both interior and surface permanent magnet motor sensorless control
- Single shunt current feedback reconstruction
- No external current or voltage sensing OP amp circuit required
- 230V/400W output power with IRAMS10UP60B, iMOTION™ Integrated Power Module
- Bootstrap diode included in IRAMS10UP60B
- Loss minimization Space Vector PWM
- Two-channel analog output (PWM)
- Embedded 8-bit high speed microcontroller (8051) for flexible I/O and man-machine control
- Isolated JTAG programming port for emulation/debugger
- I²C serial interface to EEPROM
- MCE Designer™ tool for easy operation
- Flexible drive configuration
- RS232 interface
- Over-current fault protection
- Over-voltage / Under-voltage protection
- Zero Vector Braking control
- EMI Filter included

Product Summary

Continuous output current	3.0 Arms*
Maximum overload output current	9.3 Apeak**
Maximum Internal clock (SYSCLK)	128 MHz
Sensorless control computation time	11 µsec typ.
RAM loaded from external EEPROM	48K bytes
Data RAM	8K bytes
A/D input channels	8
A/D converter resolution	12 bits
A/D converter conversion speed	2 µsec
8051 instruction execution speed	2 SYSCLK
Analog output (PWM) resolution	8 bits
RS232C baud rate (typ.)	57.6K bps

* Upgradeable to higher current with larger heat sink

** Limited by current feedback gain resistor values.



Description

IRMCS3041 is a reference design for IRMCF341, which is a high performance RAM based motion control IC designed primarily for appliance applications. It's mainly aimed to achieve simple, low cost and high performance solutions for advanced appliance motor control. The system contains an integrated power module, IRAMS10UP60B, which is also a part of iMOTION™ chipset. User can readily evaluate high performance sensorless control with MCEDesigner™ software without spending development effort usually required in the traditional DSP or microcontroller based system. The complete B/Ms, schematics and layout are provided so that the user can adapt and tailor the design per application needs.



Table of Contents

- 1 Introduction 3
 - 1.1 Overview 3
 - 1.2 Safety Precautions 4
 - 1.3 Debris When Unpacking 6
- 2 Hardware Description 7
 - 2.1 PCB 7
 - 2.2 Isolation Boundary 7
 - 2.3 IRMCF341 8
 - 2.3.1 Power 8
 - 2.3.2 Crystal 8
 - 2.3.3 Reset Circuit 8
 - 2.3.4 EEPROM 8
 - 2.3.5 Digital I/O 8
 - 2.3.6 Analog Input 8
 - 2.3.7 Single Shunt Current Feedback 8
 - 2.4 IRAM 8
 - 2.5 Power Supply 8
 - 2.6 EMI Filter 8
 - 2.7 DC Bus Capacitor 8
- 3 System Installation and Operation 9
- 4 Specifications 10

List of Figures

- Figure 1. Typical Application Block Diagram Using IRMCF341 3
- Figure 2. Top View of IRMCS3041 7

List of Tables

- Table 1. IRMCS3041 Electrical Specification 10

1 Introduction

1.1 Overview

IRMCS3041 is a reference design platform for inverter-controlled appliance motor drive applications based on iMOTION™ chipset. It contains IRMCF341 digital motion control IC, and IRAMS10UP60B, integrated power module.

IRMCF341 is International Rectifier’s new integrated circuit device primarily designed as a one-chip solution for sensorless permanent magnet motor control in appliance applications. Unlike a traditional microcontroller or DSP, IRMCF341 provides a built-in closed loop sensorless control algorithm using a unique Motion Control Engine (MCE™) for surface/interior permanent magnet motors with sinusoidal back EMF. IRMCF341 also employs a unique single shunt current reconstruction circuit to eliminate additional analog/digital circuitry and enables a direct shunt resistor interface to the IC. The MCE™ consists of a collection of control elements, motion peripherals, a dedicated motion control sequencer and dual port RAM to map internal signal nodes. Motion control programming is achieved by using a dedicated graphical compiler integrated into the MATLAB/Simulink™ development environment. Sequencing, user interface, host communication, and upper layer control tasks can be implemented in the 8051 high-speed 8-bit microcontroller. The 8051 microcontroller is equipped with a JTAG port to facilitate emulation and debugging tools. Figure 1 shows a typical application schematic using the IRMCF341.

IRMCF341 contains 48K bytes of program RAM, which can be loaded from external EEPROM for 8051 program execution. The IRMCF341 is intended for development purposes. For high volume production, IRMCK341 contains OTP ROM in place of program RAM to reduce the cost. Both IRMCF341 and IRMCK341 come in the same 64-pin QFP package with identical pin configuration to facilitate PC board layout and transition to mass production

IRAMS10UP60B is an integrated power module developed and optimized for appliance motor control. An internal shunt resistor is included and offers easy current feedback through IRMCF341 single shunt current reconstruction circuit. Built-in over-current protection and short-circuit rated IGBTs along with under-voltage lockout function and a built-in temperature monitor deliver a high level of protection and fail-safe operation. The integration of bootstrap diodes for the high-side driver section and the single polarity power supply required to drive internal circuitry simplify the utilization of the module and deliver further cost reduction advantages.

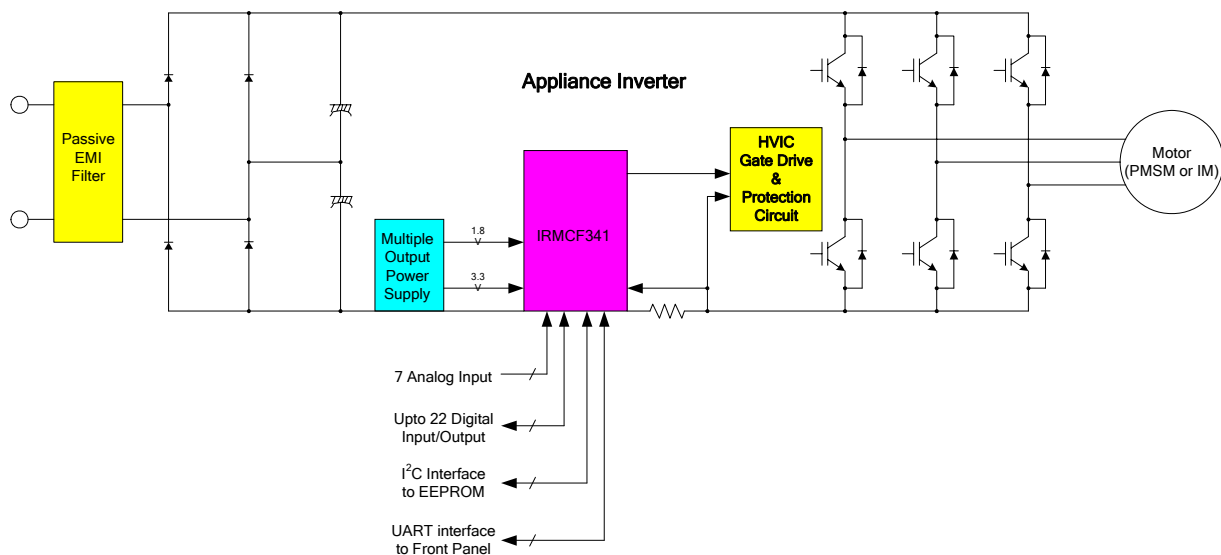

Figure 1. Typical Application Block Diagram Using IRMCF341

1.2 Safety Precautions

In addition to the precautions listed throughout this manual, please read and understand the following statements regarding hazards associated with development system.



ATTENTION: The ground potential of the IRMCS3041 system is biased to a negative DC bus voltage potential. When measuring voltage waveform by oscilloscope, the scope ground needs to be isolated. Failure to do so may result in personal injury or death. Darkened display LEDs is not an indication that capacitors have discharged to safe voltage levels.

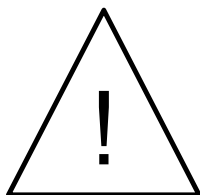

ATTENTION: IRMCS3041 system contains dc bus capacitors which take time to discharge after removal of main supply. Before working on drive system, wait three minutes for capacitors to discharge to safe voltage levels. Failure to do so may result in personal injury or death. Darkened display LEDs is not an indication that capacitors have discharged to safe voltage levels.



ATTENTION: Only personnel familiar with the drive and associated machinery should plan or implement the installation, start-up, and subsequent maintenance of the system. Failure to comply may result in personal injury and/or equipment damage.



ATTENTION: The surface temperatures of the drive may become hot, which may cause injury.

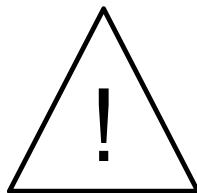

ATTENTION: IRMCS3041 system contains ESD (Electrostatic Discharge) sensitive parts and assemblies. Static control precautions are required when installing, testing, servicing or repairing this assembly. Component damage may result if ESD control procedures are not followed. If you are not familiar with static control procedures, reference applicable ESD protection handbook and guideline.



ATTENTION: An incorrectly applied or installed drive can result in component damage or reduction in product life. Wiring or application errors such as undersizing the motor, supplying an incorrect or inadequate AC supply, or excessive ambient temperatures may result in system malfunction.

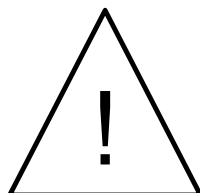

ATTENTION: Remove and lock out power from the drive before you disconnect or reconnect wires or perform service. Wait three minutes after removing power to discharge the bus voltage. Do not attempt to service the drive until bus voltage has discharged to zero. Failure to do so may result in bodily injury or death.

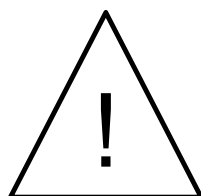

ATTENTION: Do not connect power factor correction capacitors to drive output terminals U, V, and W. Failure to do so may result in equipment damage or bodily injury.

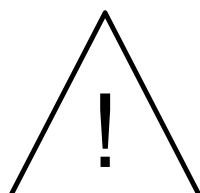

ATTENTION: IRMCS3041 system includes a field-weakening control function. However, if a drive trip occurs in field-weakening operation, excessive DC bus over-voltage will result. Users should take the necessary precautions to protect against DC bus over-voltage. Failure to do so may result in equipment damage or bodily injury.

1.3 Debris When Unpacking

IRMCS3041 system is shipped with packing materials that need to be removed prior to installation.



ATTENTION: Failure to remove all debris and packing materials which are unnecessary for system installation may result in overheating or abnormal operating condition.

2 Hardware Description

A top view of IRMCS3041 is shown in Figure 2.

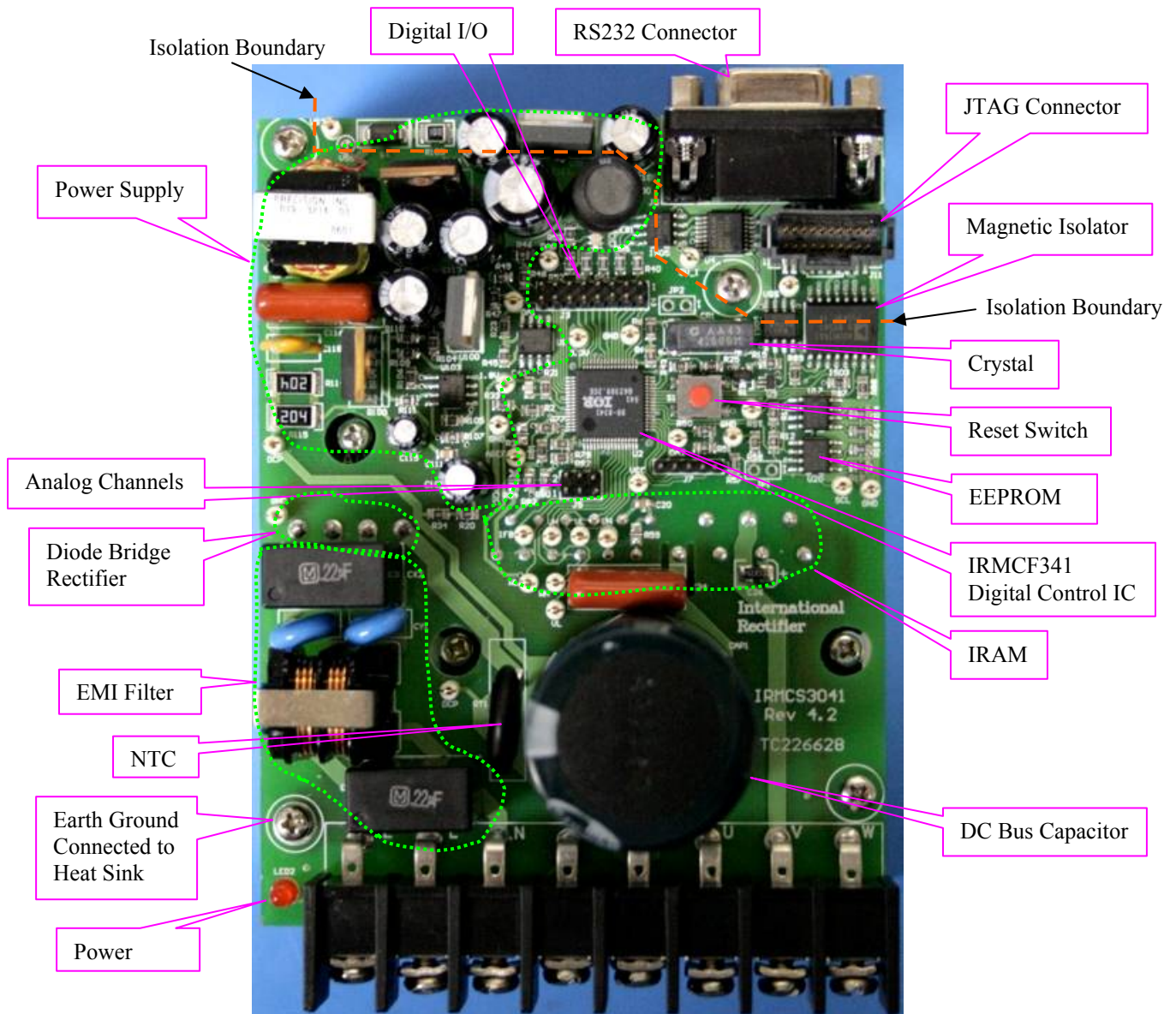

Figure 2. Top View of IRMCS3041

2.1 PCB

The printed circuit board has two electrical layers and its size is 3.5 x 4.5 inches.

2.2 Isolation Boundary

Note that there are two different grounds on this system. The RS232 connector and JTAG connector are isolated by magnetic isolators so that the user can connect their debugger and computer without isolating the computer. However, the user should keep in mind that most parts of the hardware have negative DC bus ground and it is necessary to isolate the scope when waveforms are measured.



2.3 IRMCF341

2.3.1 Power

IRMCF341 requires 3.3V and 1.8V. VDD1 is 3.3V used for I/O and VDD2 is 1.8V for digital logic. AVDD is 1.8V for analog and PLLVDD is 1.8V for PLL. Only one source of 1.8V is shared in IRMCS3041 system. Typical current value for 1.8V is less than 100mA.

2.3.2 Crystal

A 4 MHz crystal is used to generate the system clock. Actual system frequency is adjustable by changing Phase Locked Loop configuration through Special Function Registers. For more information regarding the clock, please refer to the IRMCx300 Reference Manual.

2.3.3 Reset Circuit

IRMCF341 doesn't require external RC circuit for reset. The reset switch can be used to initialize the JTAG debugger. For more information regarding reset, please refer to the IRMCx300 Reference Manual.

2.3.4 EEPROM

Boot load takes place at power-up to load 8051 code and MCE code from an external EEPROM to internal RAM of IRMCF341. EEPROM can be written by MCEDesigner.

2.3.5 Digital I/O

Only some of the digital I/O's are used in IRMCS3041. For example, 'P1.5' and 'P1.6' are used to drive the LED to indicate the status of the system. The remainders are connected to headers (J3, J7) for the user's convenience.

2.3.6 Analog Input

Analog channels are connected to header J5 for ease of use.

2.3.7 Single Shunt Current Feedback

IRMCF341 contains an Operational Amplifier for single shunt current reconstruction circuit. Resistors and capacitors for amplifier circuit are placed very close to the pins. Note that there is a separate trace from shunt resistor instead of sharing a plane with negative DC bus ground to get better current feedback.

2.4 IRAM

IRAMS10UP60B is mounted on a heat sink under the board. Voltage across 33.3 mΩ shunt is fed to 'Itrip' pin of IR21363 high voltage gate driver IC through low pass filter with 2 μsec time constant to initiate the over-current shutdown (Gatekill). For more information regarding IRAM, please refer to IRAM datasheet.

2.5 Power Supply

Switch mode power supply operates at about 80 kHz and generates 15V(VCC), 3.3V and isolated 5V. 1.8V is generated from 3.3V by a linear regulator IRU1208.

2.6 EMI Filter

Passive EMI filter on the board consists of two 0.1 μF X-caps and two 2.2 nF Y-caps and a 1 mH common mode inductor. Y-caps are connected to the heat sink through a metal bar and to J1 pin 1, which is assigned as earth ground.

2.7 DC Bus Capacitor

A 470 μF, 400 V, 85°C electrolytic capacitor is used to supply instantaneous power to IRAM. IRMCS3041 doesn't have a dynamic braking unit. In case of field weakening operation, it is recommended to use an external regenerative unit or a braking unit for safety. Pin 4(GND) and Pin 5(DCP) of J1 can be used for connecting an external unit.



3 System Installation and Operation

For information regarding hardware/software installation and operation, please refer to the IRMCS3041 Quick Start Guide.



4 Specifications

T_c = 25°C unless specified

Parameters	Values	Conditions
Input Power		
Voltage	115V-230Vrms, -20%, +10%	T _A =40°C, RthSA=1.0 °C/W
Frequency	50/60 Hz	
Input current	4A rms @nominal output	
Input line impedance	4%-8% recommended	
Output Power		
Watts	400W continuous power	Vin=230V AC, f _{PWM} =10kHz, f _O =60Hz, T _A =40°C, RthSA=1.0 °C/W, Vertically mounted to help air flow RthSA limits ΔTC to 10°C during overload
Current	3 Arms nominal, 9 Arms Overload	
Host interface (RS232C)		
TXD, RXD	10V	Typical 57.6 Kbps, single ended
JTAG interface		
TMS, TDI, TCK, TDO	3.3V	Interface with FS2 debugger
D/A		
8- bit 3 Channel	0-3.3V output	8051 software needs modification to use it.
A/D		
12-bit	0 – 1.2V	DC bus, single shunt current, AIN1-AIN6
DC bus voltage		
Maximum DC bus voltage	400V	Should not exceed 400V more than 30 sec
Minimum DC bus voltage	120V	
Current feedback		
Current sensing device	Single shunt reconstruction	PCB design may reduce the resolution
Resolution	12-bit	
Latency	1 pwm cycle	
Protection		
Output current trip level	14A peak, typical	Detection from shunt on negative DC bus line-to-line short, line-to-DC bus (-) short Re-scalable Re-scalable Re-scalable
Short circuit delay time	Maximum 7 μsec	
Critical over voltage trip	380V	
Over voltage trip	360V	
Under voltage trip	120V	
Power Device		
IRAMS10UP60B	6 IGBT/FRED + IR2136 gate driver +3 bootstrap diode + shunt resistor + NTC	Integrated over-current protection
System environment		
Ambient temperature	0 to 40°C	95% RH max. (Non-condensing)

Table 1. IRMCS3041 Electrical Specification



International
IOR Rectifier

IR WORLD HEADQUARTERS: 233 Kansas St., El Segundo, California 90245, Tel: (310) 252-7105
<http://www.irf.com> *Data and specifications subject to change without notice.*

Sales Offices, Agents and Distributors in Major Cities Throughout the World.