

5 4 3 2 1



D

C

B

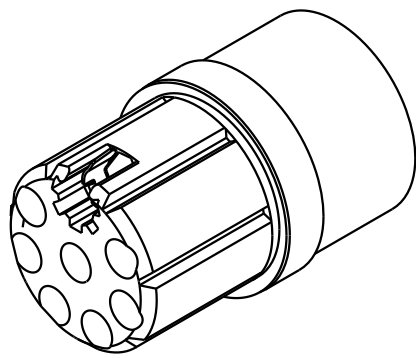
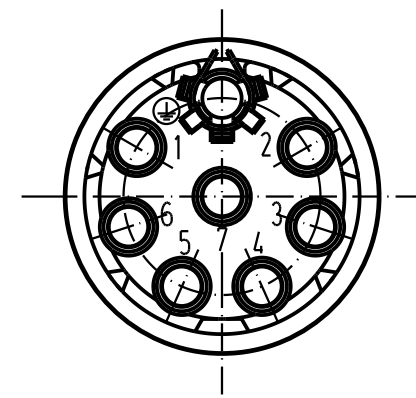
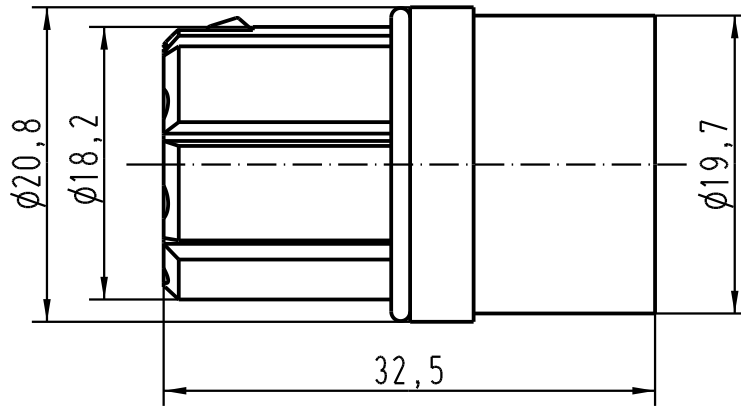
A



 All Dimensions in mm Original Size DIN A 4			Techn. Character.			Nicht tolerierte Masse/ Free size tolerances		
				Dat.	Name	Massstab/ Scale		
			Detail.	25.02.93	PENNER	2:1		
			Insp.		HERB			
			Stand.					
410609	15.07.03	DY	HARTING Electric GmbH & Co. KG			 TB 09 15 007 3021		
Mod.	Dat.	Name	D-32339 Espelkamp					Sub. TB 09 15 007 3021 v. 3.3.87
								Blatt/ page