



### Description

These integrated termination networks provide high performance line termination for GTL, GTL+, and AGTL+ busses.

The patented star circuit design combined with a ceramic substrate minimizes cross talk between channels that is common in other termination networks and resistor arrays.

The BGA packaging has been proven to reduce rework and improve reliability.

### Features

- 8 Bit, 16 Bit, and 32 Bit Termination Sets
- Compliant for GTL, GTL+, and AGTL+ Termination
- Excellent High Frequency Performance
- Slim BGA Package
- 1% Resistor Tolerance
- Low Channel to Channel Cross Talk
- RoHS Compliant Designs Available
  - Compatible with both lead and lead-free processes

### Style D

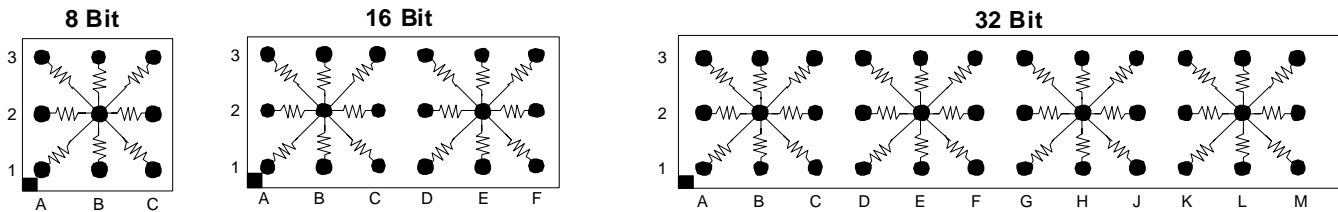

### Electrical Specifications

Resistor Tolerance:	± 1.0%
TCR	± 100ppm/°C
Operating Temperature Range	-55°C to +125°C
Maximum Resistor Power:	0.05 Watts at 70°C
Maximum Package Power:	1.0 Watts at 70°C
<b>Process Requirements:</b>	
Maximum Re-flow Temperature	Per IPC/JEDEC J-STD-020C

### Typical Application

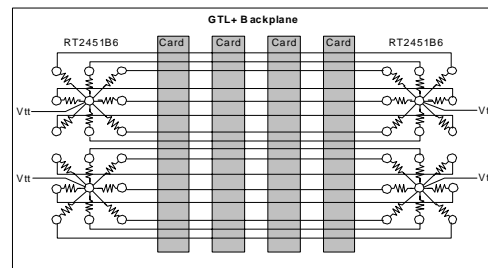

### Ordering Information

Standard Part No.	R Ohms	Bits	Pitch (mm)	RoHS Part Number
RT1450B6	25	8	1.27	RT2450B6
RT1451B6	25	16	1.27	RT2451B6
RT1452B6	25	32	1.27	RT2452B6
RT1453B6	56	8	1.27	RT2453B6
RT1454B6	56	16	1.27	RT2454B6
RT1427B6	56	32	1.27	RT2427B6
RT1410B6	150	8	1.27	RT2410B6
RT1411B6	150	16	1.27	RT2411B6
RT1412B6	150	32	1.27	RT2412B6
RT1412B7	150	32	1.00	RT2412B7

Top Probe-able part numbers are available.  
 Refer to the following link for detailed Top Side Probe-able information:  
[www.ctscorp.com/components/clearone/TopProveClearOne.pdf](http://www.ctscorp.com/components/clearone/TopProveClearOne.pdf)

### Packaging Information

Suffix	TR7	TR13
Tape Width	24 mm	24mm
Carrier Pitch	8 mm	8 mm
Reel Diameter	7 inch	13 inch
Parts/Reel	1,000	4,000

**Part Number Coding**  
 7 inch reel, Add TR7 to part number, example RT2415B7TR7  
 13 inch reel, Add TR13 to part number, example RT2415B7TR13  
 (Bulk packaging is not available)

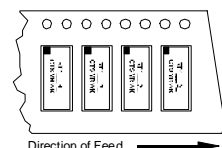

### Recommended Land Pattern

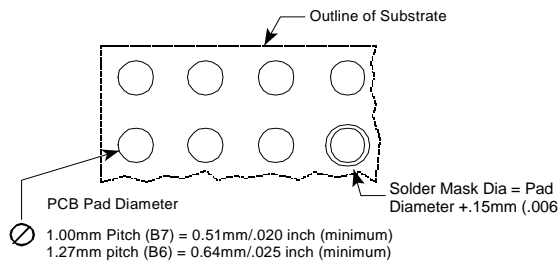

For .006" Thick Solder Paste Stencil, Aperture Opening Should be Equal to the PCB Pad Diameter.

Refer to [www.ctscorp.com/components/clearone.asp](http://www.ctscorp.com/components/clearone.asp) for additional PCB design information

### Routing Examples

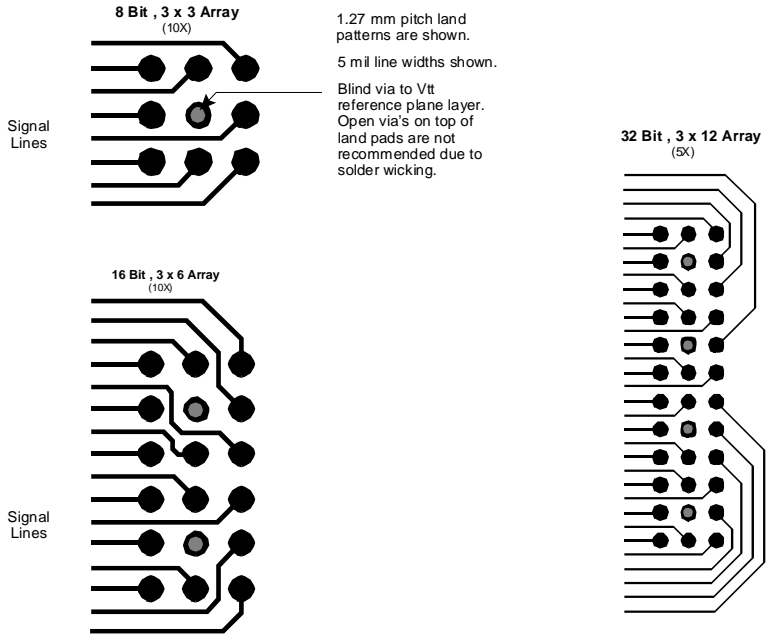

### Frequency Performance (50 ohm Network)

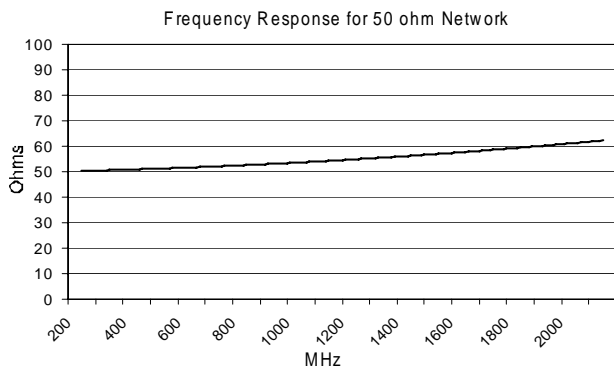

### Cross Talk Performance (50 ohm Network)

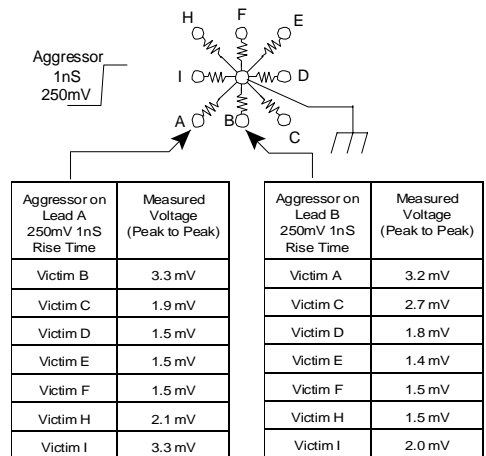

**Mechanical Diagram**

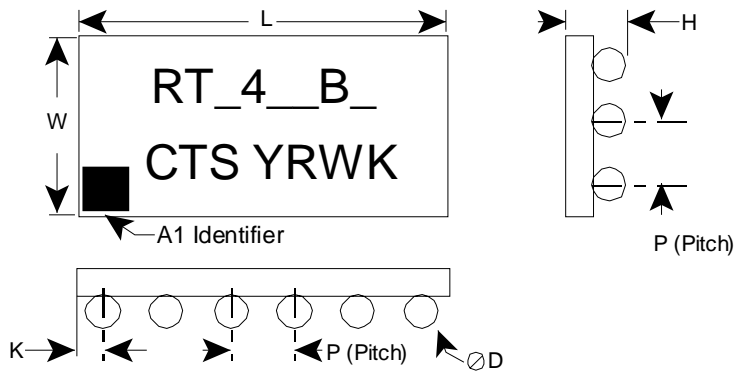

1.27mm Pitch		L	W	H	P	D	K
3 x 3 Array (8 Bit)	mm	3.81±0.15	3.81±0.15	1.32±0.15	1.27±0.25	0.76±0.05	0.64±0.25
	inch	.150±.006	.150±.006	.052±.006	.050±.010	.030±.002	.025±.010
3 x 6 Array (16 Bit)	mm	7.62±0.15	3.81±0.15	1.32±0.15	1.27±0.25	0.76±0.05	0.64±0.25
	inch	.300±.006	.150±.006	.052±.006	.050±.010	.030±.002	.025±.010
3 x 12 Array (32 Bit)	mm	15.24±0.15	3.81±0.15	1.32±0.15	1.27±0.25	0.76±0.05	0.64±0.25
	inch	.600±.006	.150±.006	.052±.006	.050±.010	.030±.002	.025±.010
1.00mm Pitch		L	W	H	P	D	K
3 x 12 Array (32 Bit)	mm	12.00±0.15	3.00±0.15	1.19±0.15	1.00±0.25	0.64±0.05	0.50±0.25
	inch	.472±.006	.118±.006	.047±.006	.039±.010	.025±.002	.020±.010

Complete ClearONE Product, Processing, and Application Information can be found at the following link:

<http://www.ctscorp.com/components/clearone.asp>