

ASSEMBLY - VIEW FROM TOP

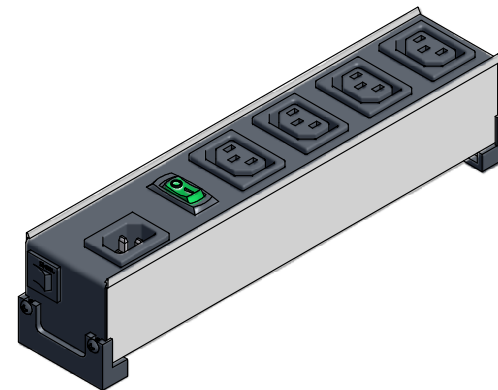

ISOMETRIC VIEW

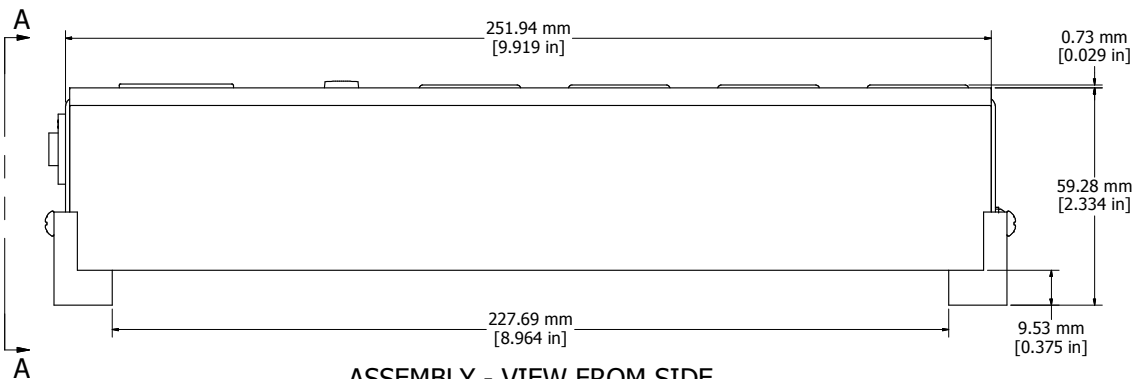

ASSEMBLY - VIEW FROM SIDE

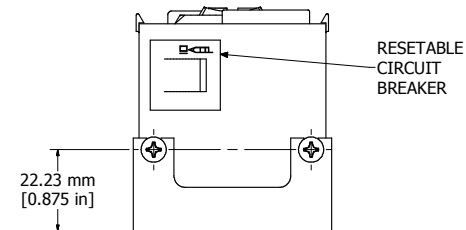

VIEW A-A

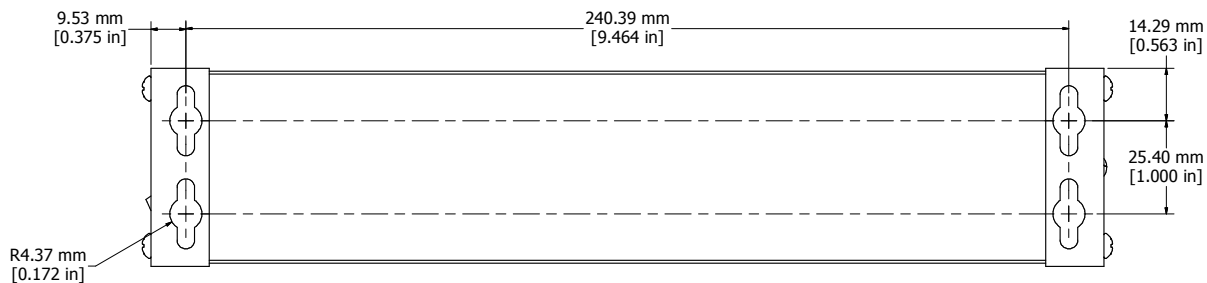

ASSEMBLY - VIEW FROM BOTTOM

1581H4
Finish - Top - Black Painted Steel
Bottom - Aluminum Extrusion
Rated - 230 VAC, 50/60 Hz, 10 Amps
Approvals - CSA Certified Standards C22.2 (No. 21-95, 42-99)
- cULus Listed Standards UL60950 & CSA C22.2 No. 60950
- TUV-GS Certified Standards EN60335-1 & EN60950-1
- CE Certified Registration #: AN 72031916 0001

