

ANTI-SATURATION FILTERLESS 3W CLASS-D STEREO AMPLIFIER WITH DC VOLUME CONTROL AND HEADPHONE OUTPUT

Description

The PAM8603A is a 3W, Class-D audio amplifier with headphone amplifier. Advanced 64-Step DC volume control minimizes external components and allows speaker volume control and headphone volume control. PAM unique antisaturation technology which detects output signal clip due to the over level input signal suppress the output signal clip automatically. Also the antisaturation function can adapt the output clip caused by power supply voltage down with battery. It offers low THD+N, to produce highquality sound reproduction. The new filterless architecture allows the device to drive the speaker directly, without low-pass output filters which will save system cost and PCB area.

With the same numbers of external components, the efficiency of the PAM8603A is much better than Class-AB cousins. It can extend the battery life thus be ideal for portable applications.

The PAM8603A is available in a SSOP-24 package.

Features

- 3W Output at 10% THD with a 4Ω Load and 5V Power Supply
- Filterless, Low Quiescent Current and Low EMI
- Low THD+N
- 64-Step DC Volume Control
- Headphone Output Function
- Unique Anti-Saturation Function
- Superior Low Noise
- Low Pop Noise
- Efficiency Up to 90%
- Short Circuit Protection
- Thermal Shutdown
- Few External Components to Save the Space and Cost
- Pb-Free Package

Pin Assignments

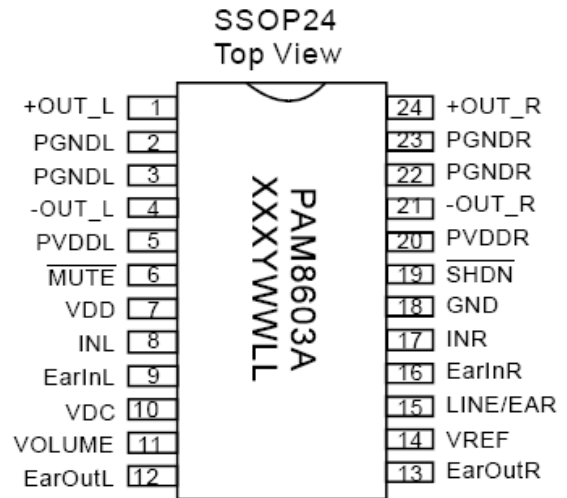

Applications

- LCD Monitors / TV Projectors
- Notebook Computers
- Portable Speakers
- Portable DVD Players, Game Machines
- VoIP/Speakers Phones

Typical Applications Circuit

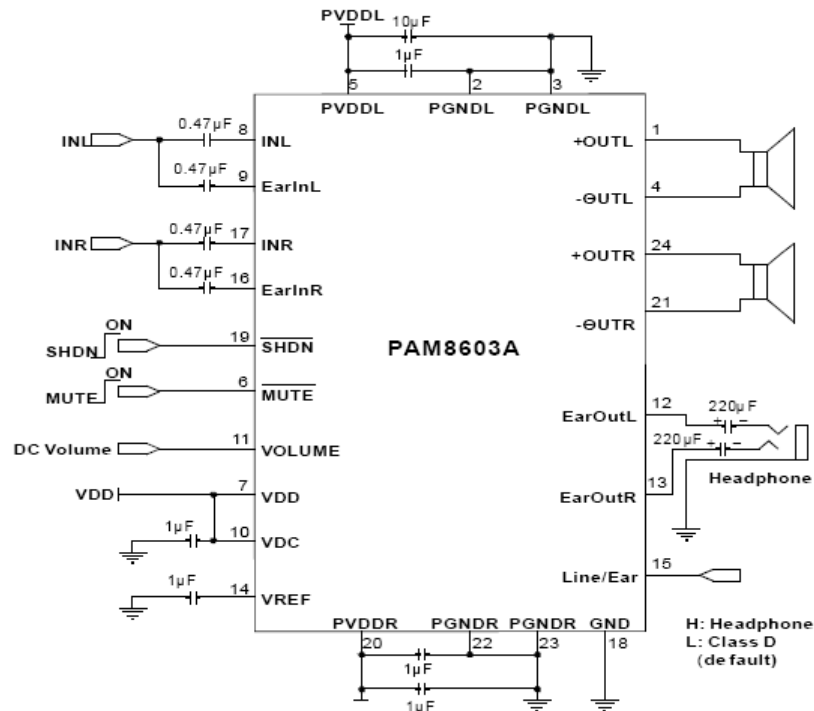

Pin Descriptions

Pin Number	Pin Name	Function
1	+OUT_L	Left Channel Positive Output
2	PGNDL	Left Channel Power GND
3	PGNDL	Left Channel Positive GND
4	-OUT_L	Left Channel Negative Output
5	PVDDL	Left Channel Power Supply
6	MUTE	Mute Control Input (active low)
7	VDD	Analog VDD
8	IN L	Left Channel Input
9	EAR IN L	Left Earphone Input
10	VDC	Analog Reference for gain Control Section
11	VOLUME	DC Voltage Control to Set the Gain of Class-D
12	EAR OUT L	Left Earphone Output
13	EAR OUT R	Right Earphone Output
14	VREF	Internal Analog Reference, Connect a Bypass Capacitor from VREF to GND
15	LINE/EAR	Line/ Ear Detect
16	EAR IN R	Right Earphone Input
17	INR	Right Channel Input
18	GND	Analog GND
19	SHDN	Shutdown Control Input (active low)
20	PVDDR	Right Channel Power Supply
21	-OUT_R	Right Channel Negative Output
22	PGNDR	Right Channel Power GND
23	PGNDR	Right Channel Power GND
24	+OUT_R	Right Channel Positive Output

Functional Block Diagram

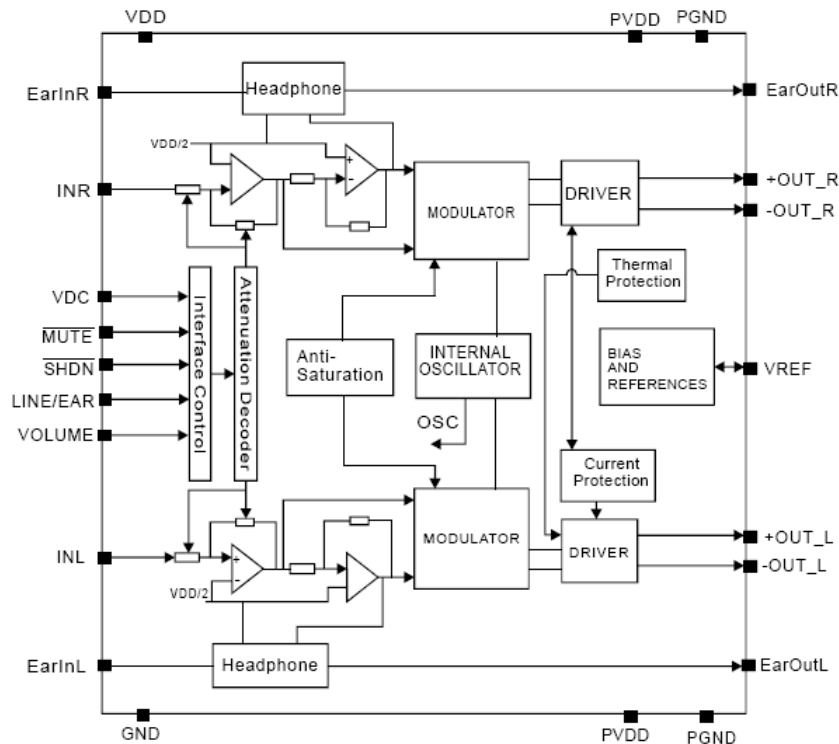

Absolute Maximum Ratings (@T_A = +25°C, unless otherwise specified.)

These are stress ratings only and functional operation is not implied. Exposure to absolute maximum ratings for prolonged time periods may affect device reliability. All voltages are with respect to ground.

Parameter	Rating	Unit
Supply Voltage	6.0	V
Input Voltage	-0.3 to V _{DD} +0.3	
Maximum Junction Temperature	150	°C
Storage Temperature	-65 to +150	
Soldering Temperature	300, 5 sec	

Recommended Operating Conditions (@T_A = +25°C, unless otherwise specified.)

Parameter	Rating	Unit
Supply Voltage Range	2.5 to 5.5	V
Ambient Temperature Range	-20 to +85	°C
Junction Temperature Range	-20 to +125	°C

Thermal Information

Parameter	Package	Symbol	Max	Unit
Thermal Resistance (Junction to Ambient)	SSOP-24	θ _{JA}	96	°C/W

Electrical Characteristics (@T_A = +25°C, V_{DD} = 5V, Gain = Maximum, R_L = 8Ω, unless otherwise specified.)

Parameter	Symbol	Test Conditions		Min	Typ	Max	Units
Class D Stage							
Supply Voltage Range	V _{DD}			2.5		5.5	V
Quiescent Current	I _Q	No Load			10	15	mA
Output Offset Voltage	V _{OS}	No Load			10	50	mV
Drain-Source On-State Resistance	R _{DS(ON)}	I _{DS} = 0.5A	P MOSFET		0.35		Ω
			N MOSFET		0.25		
Output Power	P _O	THD+N = 10%, f = 1kHz, Anti-saturation off	R _L = 8Ω	1.55	1.70		W
			R _L = 4Ω	2.85	3.00		
		THD+N = 1%, f = 1kHz, Anti-saturation off	R _L = 8Ω	1.10	1.35		
			R _L = 4Ω	2.3	2.5		
Total Harmonic Distortion Plus Noise	THD+N	R _L = 8Ω, P _O = 0.85W, f = 1KHz			0.08		%
		R _L = 4Ω, P _O = 1.75W, f = 1KHz			0.08		
Power Supply Ripple Rejection	PSRR	Input AC-GND, f = 1KHz, V _{PP} = 200mV, Gain = 2V/V			-70		dB
Channel Separation	CS	P _O = 1W, f = 1KHz			-95		dB
Oscillator Frequency	f _{osc}			200	250	300	kHz
Efficiency	η	P _O = 1.7W, f = 1 kHz, R _L = 8Ω		85	89		%
		P _O = 3.0W, f = 1 kHz, R _L = 4Ω		80	83		%
Noise	V _N	Input AC-GND	A-Weighting		220		μV
			No A-Weighting		350		
Signal Noise Ratio	SNR	f = 20 – 20kHz, THD = 1%			85		dB
Earphone Stage							
Quiescent Current	I _Q	No Load			4.5	7.5	mA
Output Offset Voltage	V _{OS}	No Load			2.5		V
Output Power	P _O	THD+N = 1%, R _L = 32Ω, f = 1KHz			60		mW
Total Harmonic Distortion Plus Noise	THD+N	R _L = 32Ω, P _O = 10mW, f = 1kHz			0.02		%
Power Supply Ripple Rejection	PSRR	Input AC-GND, f = 1kHz, V _{PP} = 200mV			-75		dB
Channel Separation	CS	P _O = 1W, f = 1kHz			-85		dB
Noise	V _N	Input AC-GND	A-Weighting		40		μV
			No A-Weighting		70		
Signal Noise Ratio	SNR	f = 20 – 20kHz, V _O = 1V _{RMS}			85		dB
Control Section							
Under Voltage Lock-Out	UVLO				2		
Mute Current	I _{MUTE}	V _{MUTE} = 0V			1	3	mA
Shutdown Current	I _{SHDN}	V _{SHDN} = 0V				1	μA
Ear/ Line Threshold Voltage	V _{TH}				0.65		
SHDN Input High	V _{SH}			1.2			
SHDN Input High	V _{SL}					0.5	
MUTE Input High	V _{MH}			1.2			
MUTE Input High	V _{ML}					0.5	
Over Temperature Protection	OTP				140		°C
Over Temperature Hysteresis	OTH				30		°C

Typical Performance Characteristics (@ $T_A = +25^\circ\text{C}$, $V_{DD} = 5\text{V}$, $R_L = 8\Omega$, $G_V = 24\text{dB}$, unless otherwise specified.)

Class-D Output

1. THD+N vs Output Power vs Input

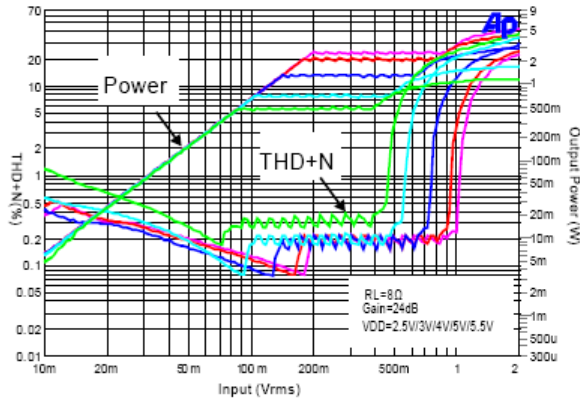

2. THD+N vs Output Power vs Input

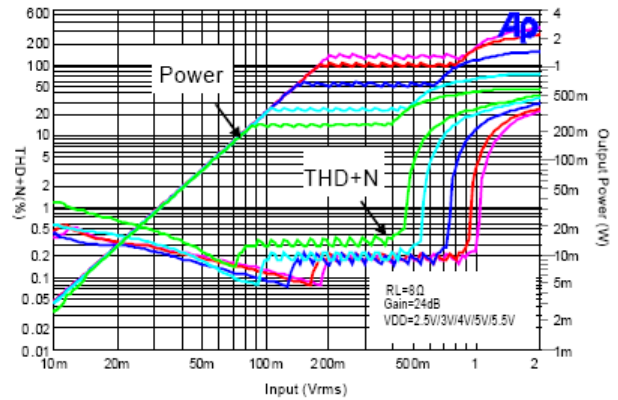

3. THD+N vs Frequency

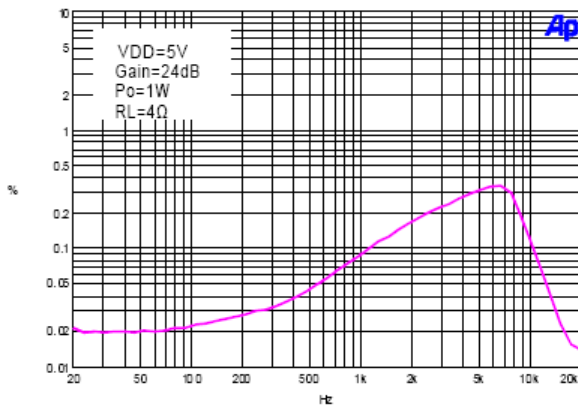

4. THD+N vs Frequency

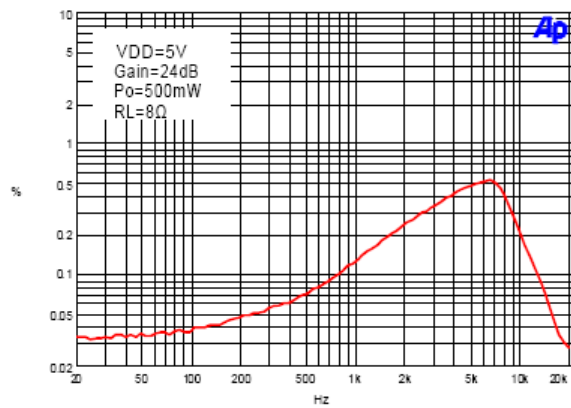

5. PSRR vs Frequency

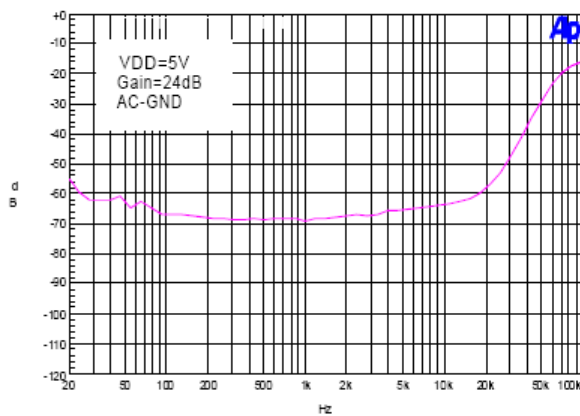

6. Crosstalk vs Frequency

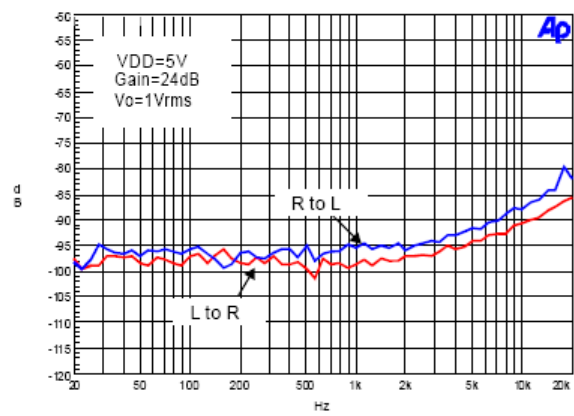

Typical Performance Characteristics (cont.) (@ $T_A = +25^\circ\text{C}$, $V_{DD} = 5\text{V}$, $R_L = 8\Omega$, $G_v = 24\text{dB}$, unless otherwise specified.)

Class-D Output

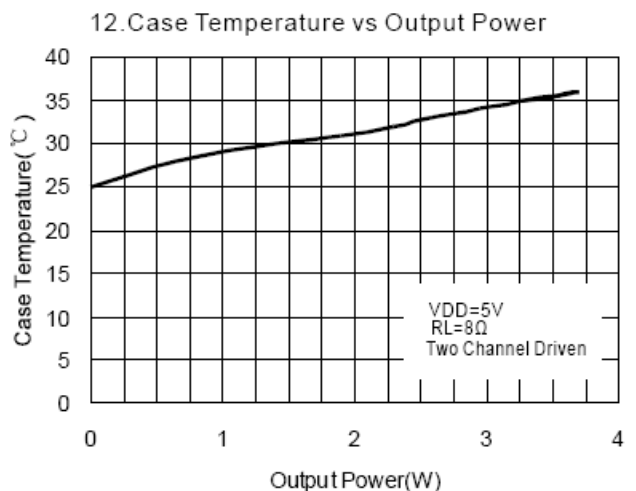
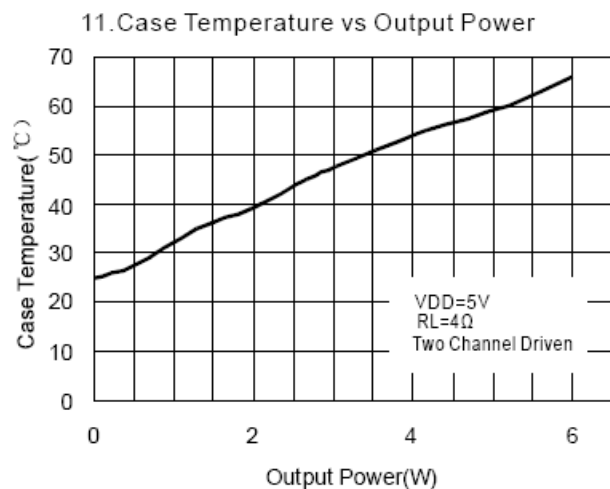
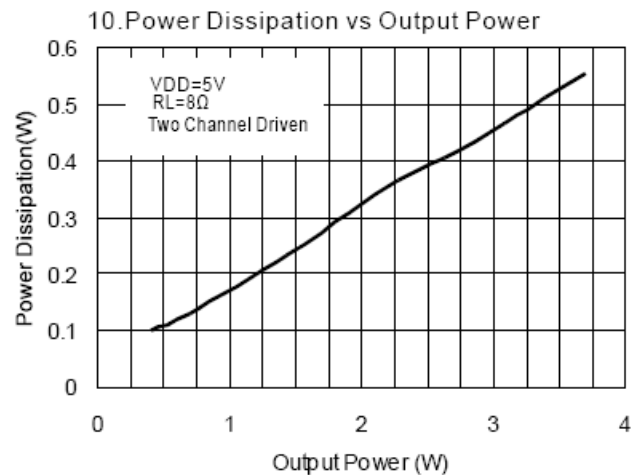
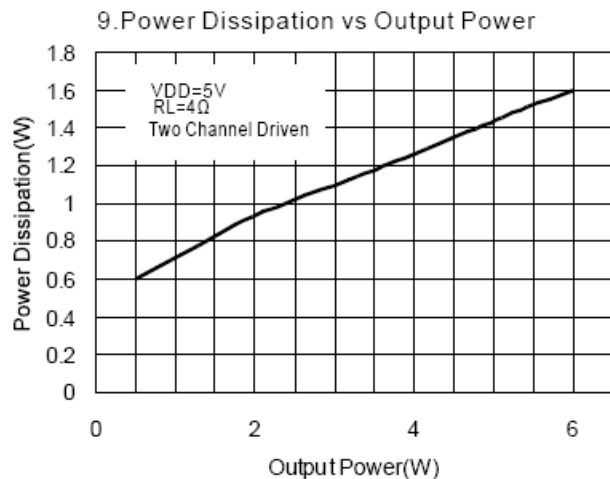
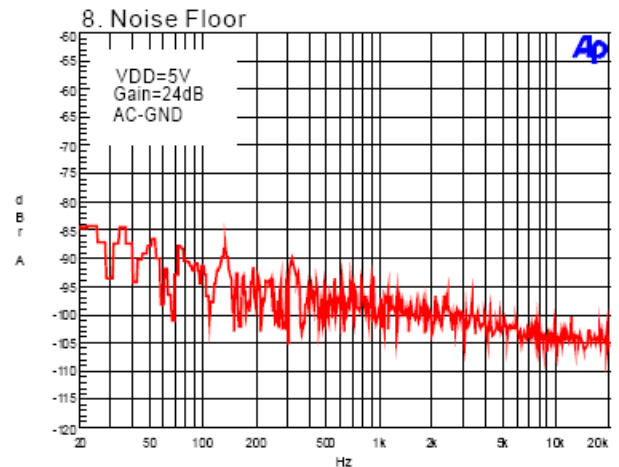
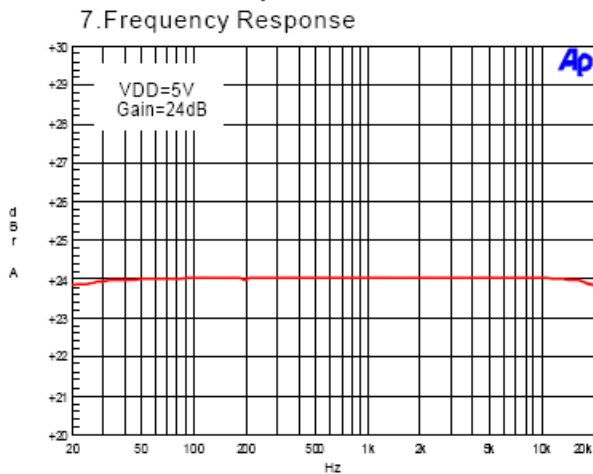

Typical Performance Characteristics (cont.) (@ $T_A = +25^\circ\text{C}$, unless otherwise specified.)

Earphone Output

13. THD+N vs. Power

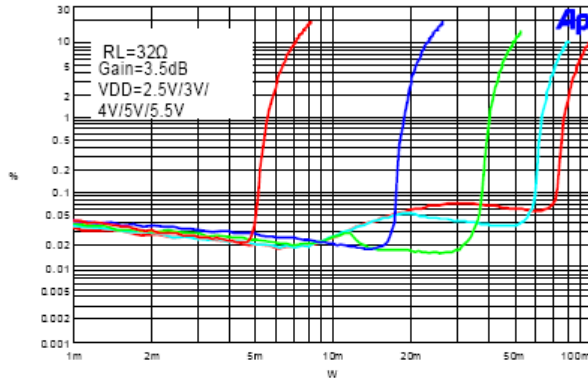

14. THD+N vs. Frequency

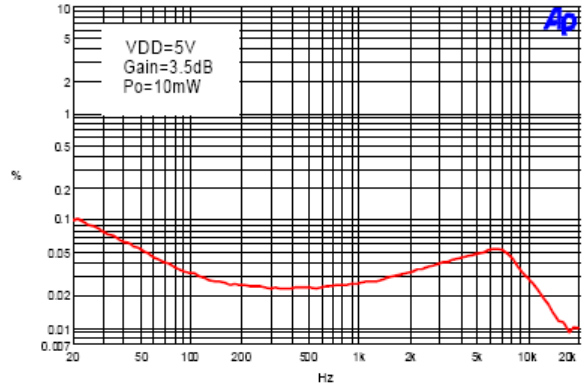

15. Crosstalk vs Frequency

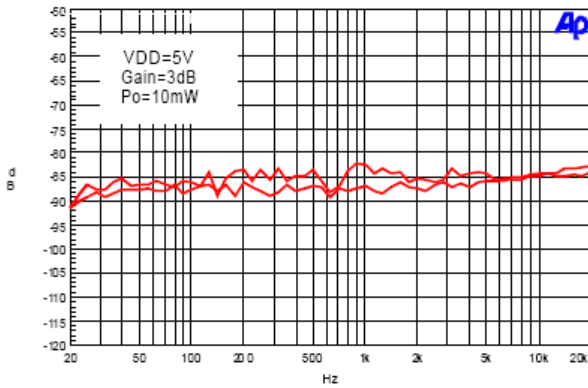

16. Frequency Response

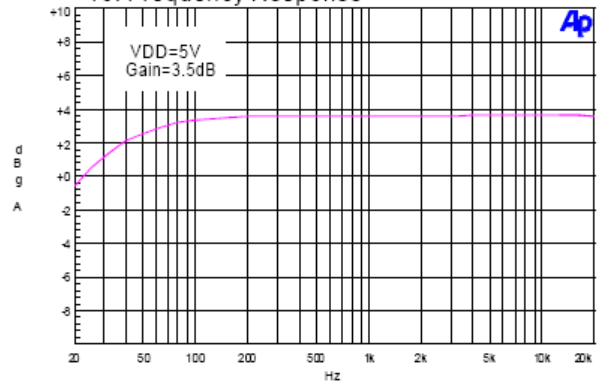

17. PSRR

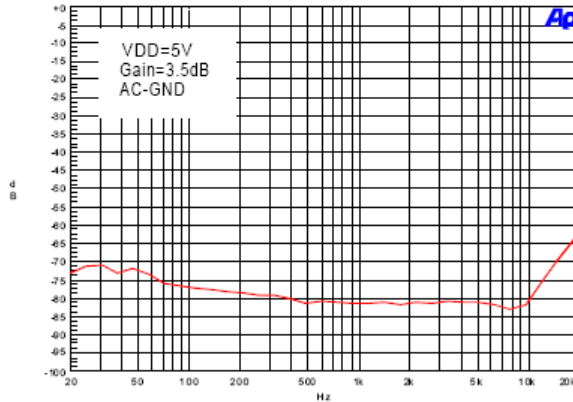

18. Noise Floor

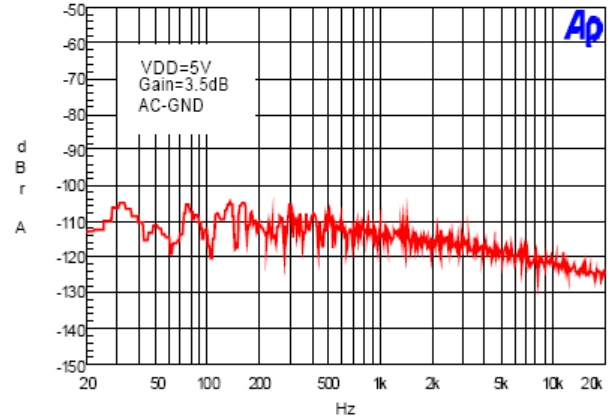

Typical Performance Characteristics (cont.) (@ $T_A = +25^\circ\text{C}$, unless otherwise specified.)

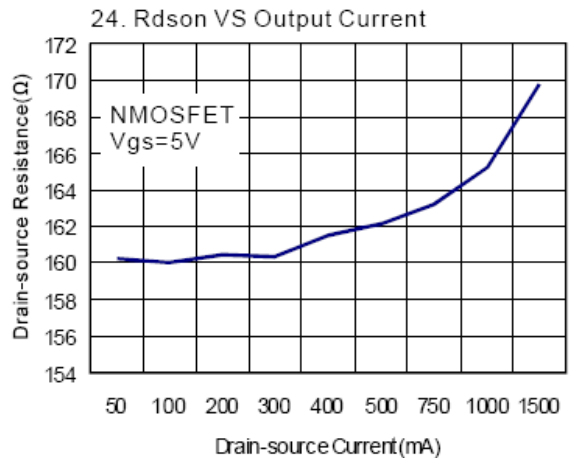
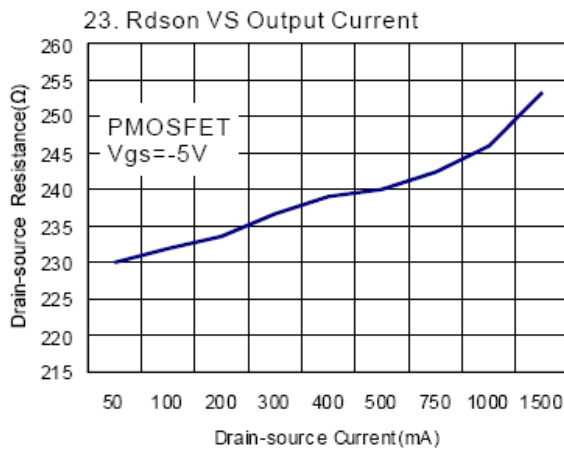
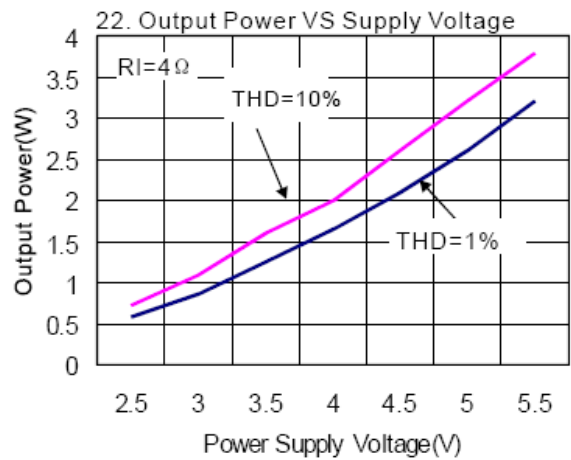
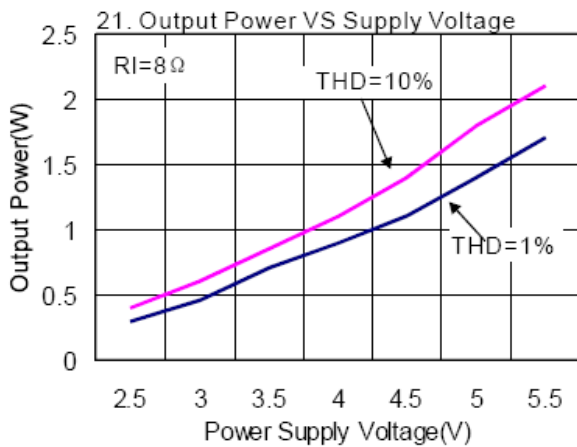
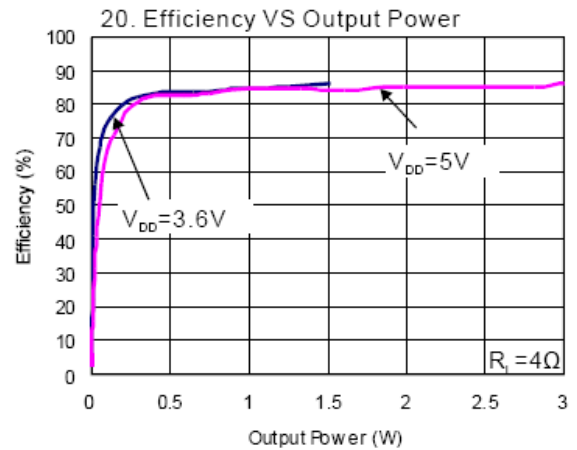
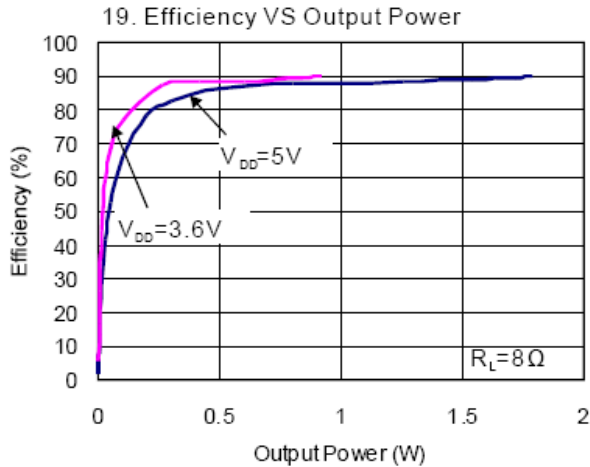

Typical Performance Characteristics (cont.) (@ $T_A = +25^\circ\text{C}$, $V_{DD} = 5\text{V}$, $G_V = 10\text{dB}$, unless otherwise specified.)

25. Quiescent Current (Class D)

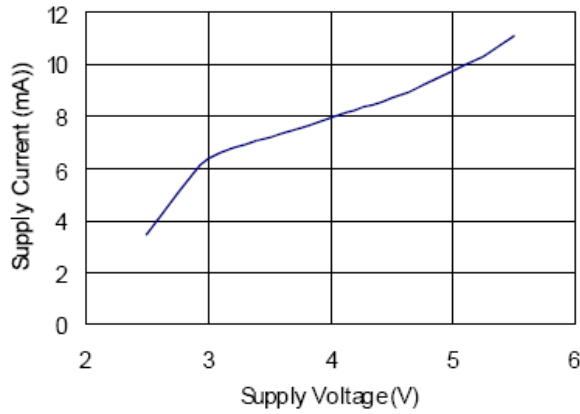

26. Quiescent Current (Earphone)

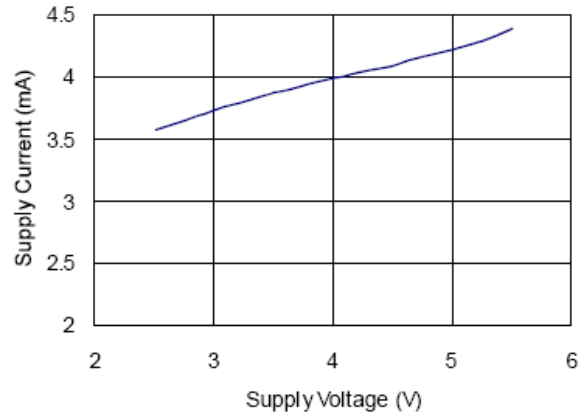

27. Shutdown Current

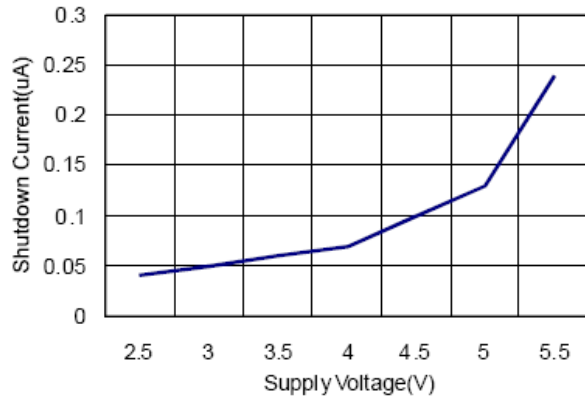

28. Switching Frequency (Class D)

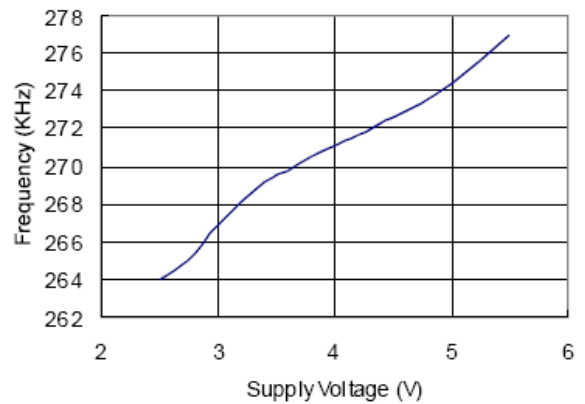

29. Gain Control (Class D)

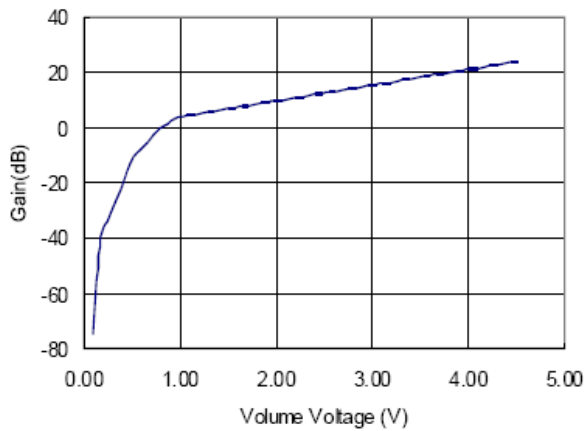

30. Gain Control (Earphone)

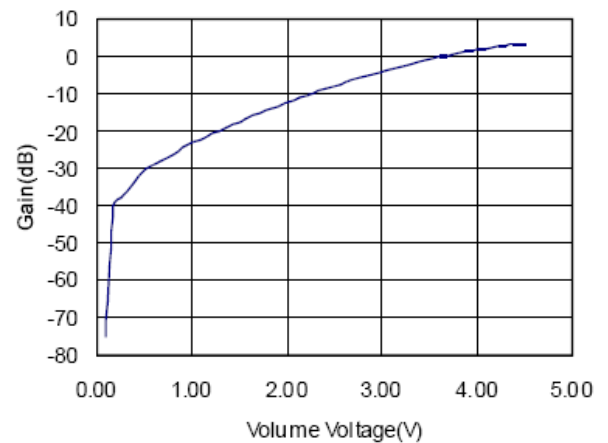

Typical Performance Characteristics (cont.) (@T_A = +25°C, unless otherwise specified.)

Table 1. DC Volume Control

STEP	Gain (dB) Class D	Gain (dB) Earphone		STEP	Gain (dB) Class D	Gain (dB) Earphone
0	-75	-75		32	11.6	-9.2
1	-40	-40		33	12.0	-8.6
2	-34	-38		34	12.4	-8.0
3	-28	-36		35	12.8	-7.4
4	-22	-34		36	13.2	-6.8
5	-16	-32		37	13.6	-6.2
6	-10	-30		38	14.0	-5.7
7	-7.5	-29		39	14.4	-5.2
8	-5.0	-28		40	14.8	-4.7
9	-2.5	-27		41	15.2	-4.2
10	0	-26		42	15.6	-3.7
11	1.5	-25		43	16.0	-3.2
12	3.0	-24		44	16.4	-2.7
13	4.0	-23		45	16.8	-2.2
14	4.4	-22.2		46	17.2	-1.8
15	4.8	-21.4		47	17.6	-1.4
16	5.2	-20.6		48	18.0	-1.0
17	5.6	-19.8		49	18.4	-0.6
18	6.0	-19.0		50	18.8	-0.2
19	6.4	-18.2		51	19.2	0.2
20	6.8	-17.4		52	19.6	0.6
21	7.2	-16.6		53	20.0	0.9
22	7.6	-15.9		54	20.4	1.2
23	8.0	-15.2		55	20.8	1.5
24	8.4	-14.5		56	21.2	1.8
25	8.8	-13.8		57	21.6	2.1
26	9.2	-13.1		58	22.0	2.4
27	9.6	-12.4		59	22.4	2.7
28	10.0	-11.7		60	22.8	2.9
29	10.4	-11.0		61	23.2	3.1
30	10.8	-10.4		62	23.6	3.3
31	11.2	-9.8		63	24.0	3.5

Application Information

Test Setup for Performance Testing (Class D)

1. When the PAM8603A works with LC filters, it should be connected with the speaker before it's powered on, otherwise it will be damaged easily.
2. When the PAM8603A works without LC filters, it's better to add a ferrite chip bead at the outgoing line of speaker for suppressing the possible electromagnetic interference.
3. The absolute maximum rating of the PAM8603A operation voltage is 6V. When the PAM8603A is powered with four battery cells, it should be noted that the voltage of four new dry or alkaline batteries is over 6V, higher than its maximum operation voltage, which probably make the device damaged. Therefore, it's recommended to use either four Ni-MH (Nickel Metal Hydride) rechargeable batteries or three dry or alkaline batteries.
4. The input signal should not be too high, if too high, it will cause the clipping of output signal when increasing the volume. Because the DC volume control of the PAM8603A has big gain, it will make the device damaged.
5. When testing the PAM8603A without LC filters by using resistor instead of speaker as the output load, the test results, e.g. THD or efficiency, will be worse than those using speaker as load.

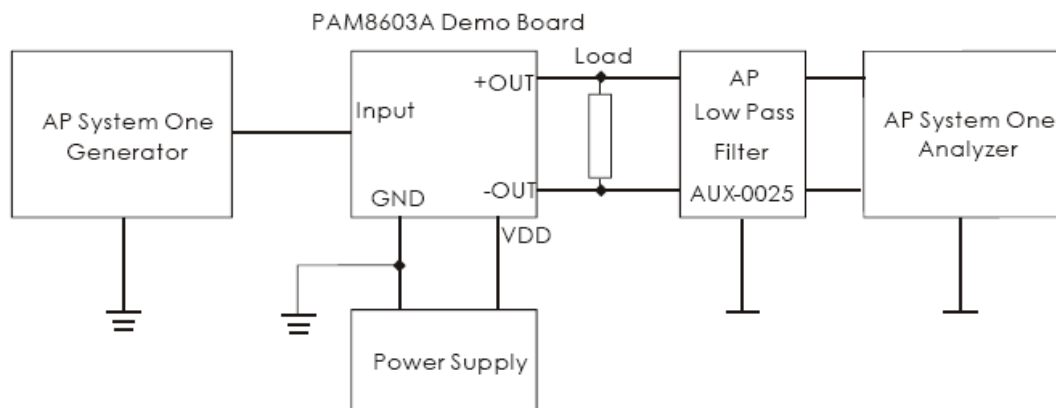

- Notes:
1. The Audio Precision (AP) AUX-0025 low pass filter is necessary for class-D amplifier measurement with AP analyzer.
 2. Two 22 μ H inductors are used in series with load resistor to emulate the small speaker for efficiency measurement.

Anti-saturation Function

If the preset gain is higher than 12dB, Anti-saturation is active by detecting the duty cycle of the PWM output when the mode is detected, the gain is automatically adjusted to the value that the output is not clipped step by step. The maximum attenuation is -12dB (preset gain = 24dB). The attack is immediate and the release time is 250ms per step.

Mute Operation

The $\overline{\text{MUTE}}$ pin is an input for controlling the output state of the PAM8603A. A logic low on this pin disables the outputs, and a logic high enables the outputs. This pin may be used as a quick disable or enable of the outputs without a volume fade. Quiescent current is listed in the electrical characteristic table. The $\overline{\text{MUTE}}$ pin can be left floating due to the internal pull-up.

Shutdown Operation

In order to reduce power consumption while not in use, the PAM8603A contains shutdown circuitry to turn off the amplifier's bias circuitry. The amplifier is turned off when logic low is placed on the $\overline{\text{SHDN}}$ pin. By switching the $\overline{\text{SHDN}}$ pin connected to GND, the PAM8603A supply current draw will be minimized in idle mode. The $\overline{\text{SHDN}}$ pin can be left floating due to the pull-up.

For the best power on/off pop performance, the amplifier should be placed in the Mute mode prior to turning on/off the power supply.

Application Information

Power Supply Decoupling

The PAM8603A is a high performance CMOS audio amplifier that requires adequate power supply decoupling to ensure the output THD and PSRR are as low as possible. Power supply decoupling affects low frequency on the power supply leads for higher frequency response. Optimum decoupling is achieved by using two capacitors of different types that target different types of noise frequency transients, spike, or digital hash on the line, a good low equivalent-series-resistance (ESR) ceramic capacitor, typically 1.0 μ F, placed as close as possible to the device V_{DD} terminal works best. For filtering lower-frequency noise signals, a large capacitor of 10 μ F (ceramic) or greater placed near the audio power amplifier is recommended.

Input Capacitor (C_i)

Large input capacitors are both expensive and space hungry for portable designs. Clearly, a certain sized capacitor is needed to couple in low frequencies without severe attenuation. But in many cases the speakers used in portable systems, whether internal or external, have little ability to reproduce signals below 100Hz to 150Hz. Thus, using a large input capacitor may not increase actual system performance. In this case, input capacitor (C_i) and input resistance (R_i) of the amplifier form a high-pass filter with the corner frequency determined equation below,

$$f_c = \frac{1}{2\pi R_i C_i}$$

In addition to system cost and size, click and pop performance is affected by the size of the input coupling capacitor, C_i . A larger input coupling capacitor requires more charge to reach its quiescent DC voltage (nominally $\frac{1}{2} V_{DD}$). This charge comes from the internal circuit via the feedback and is apt to create pops upon device enable. Thus, by minimizing the capacitor size based on necessary low frequency response, turn-on pops can be minimized.

Analog Reference Bypass Capacitor (C_{BYP})

Analog Reference Bypass Capacitor (C_{BYP}) is the most critical capacitor and serves several important functions. During start-up or recovery from shutdown mode, C_{BYP} determines the rate at which the amplifier starts up. The second function is to reduce noise produced by the power supply caused by coupling into the output drive signal. This noise is from the internal analog reference to the amplifier, which appears as degraded PSRR and THD+N.

A ceramic bypass capacitor (C_{BYP}) of 0.47 μ F to 1.0 μ F is recommended for the best THD and noise performance. Increasing the bypass capacitor reduces clicking and popping noise from power on/off and entering and leaving shutdown.

Under Voltage Lock-Out (UVLO)

The PAM8603A incorporates circuitry designed to detect when the supply voltage is low. When the supply voltage drops to 1.8V or below, the PAM8603A outputs are disabled, and the device comes out of this state and states to normal functional once $V_{DD} \geq 2.0V$.

Short Circuit Protection (SCP)

The PAM8603A has short circuit protection circuitry on the outputs that prevents the device from damage when output-to-output and output-to-GND short. When a short circuit is detected on the outputs, the outputs are disabled immediately. If the short was removed, the device activates again.

Over Temperature Protection

Thermal protection on the PAM8603A prevents the device from damage when the internal die temperature exceeds +135°C. There is a 15 degree tolerance on this point from device to device. Once the die temperature exceeds the thermal set point, the device outputs are disabled. This is not a latched fault. The thermal fault is cleared once the temperature of the die is reduced by 30°C. This large hysteresis will prevent motor boating sound well. The device begins normal operation at this point without external system interaction.

Application Information

How to Reduce EMI (Electro Magnetic Interference)

A simple solution is to put an additional capacitor 1000 μ F at power supply terminal for power line coupling if the traces from amplifier to speakers are short (< 20CM).

Most applications require a ferrite bead filter as shown at Figure 1. The ferrite filter reduces EMI around 1MHz and higher. When selecting a ferrite bead, choose one with high impedance at high frequencies, and low impedance at low frequencies (MH2012HM221-T).

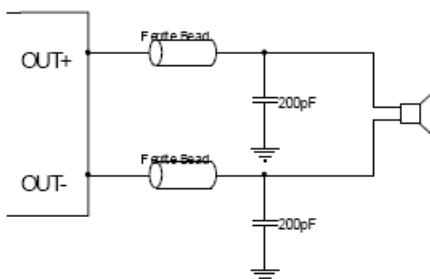
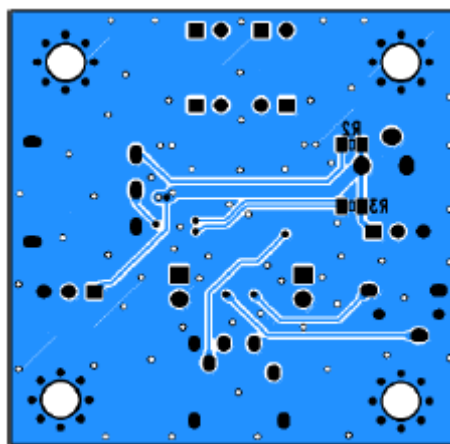
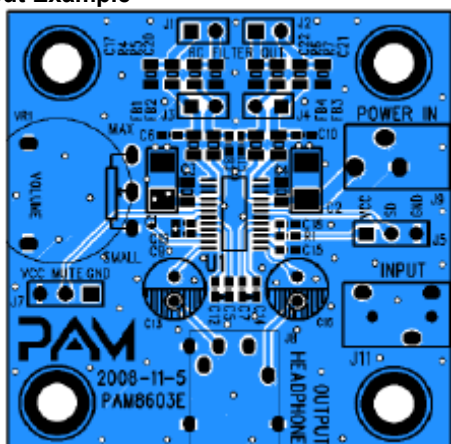

Figure 1. Ferrite Bead Filter to Reduce EMI

PCB Layout Guidelines Grounding

At this stage it is paramount to notice the necessity of separate grounds. Noise currents in the output power stage need to be returned to output noise ground and nowhere else. Were these currents to circulate elsewhere, they may get into the power supply, the signal ground, etc, worse yet, they may form a loop and radiate noise. Any of these cases results in degraded amplifier performance. The logical returns for the output noise currents associated with Class-D switching are the respective PGND pins for each channel. The switch state diagram illustrates that PGND is instrumental in nearly every switch state. This is the perfect point to which the output noise ground trace should return. Also note that output noise ground is channel specific. A two channel amplifier has two separate channels and consequently must have two separate output noise ground traces. The layout of the PAM8603A offers separate PGND connections for each channel and in some cases each side of the bridge. Output noise grounds must be tied to system ground at the power in exclusively. Signal currents for the inputs, reference, etc need to be returned to quiet ground. This ground is only tied to the signal components and the GND pin, and GND then tied to system ground.

PCB Layout Example



Ordering Information

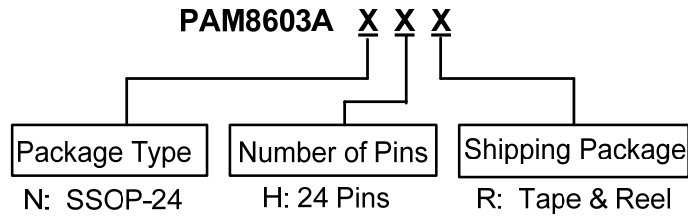

Part Number	Package Type	Standard Package
PAM8603ANHR	SSOP-24	2500 Units/Tape&Reel

Marking Information

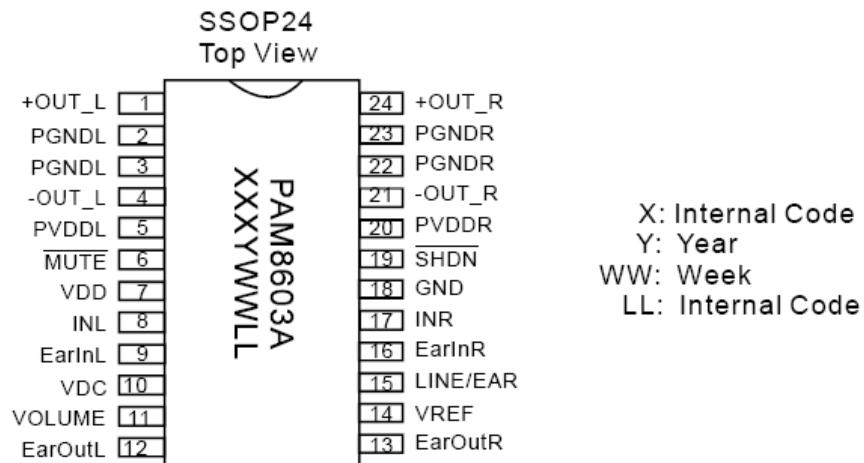

Package Outline Dimensions (All dimensions in mm.)

SSOP-24

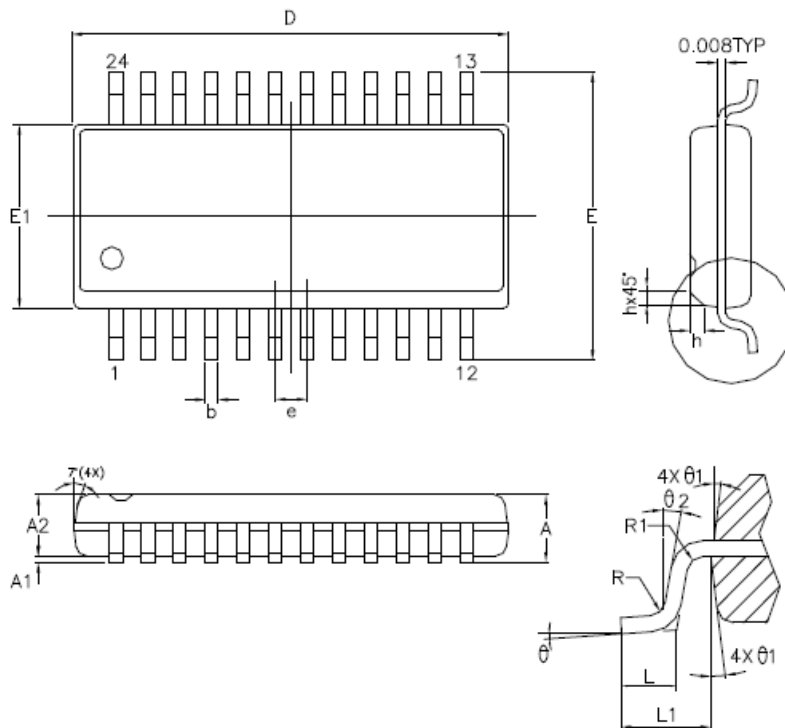

SYMBOLS	MIN.	NOM.	MAX.
A	0,053	0,061	0,069
A1	0,004	—	0,010
A2	0,049	0,057	0,065
b	0,008	0,010	0,012
D	0,335	0,341	0,347
E	0,228	0,236	0,244
E1	0,150	0,154	0,158
e	—	0,025	—
L	0,016	0,033	0,050
L1	0,041 REF		
R	0,003	—	—
R1	0,003	—	—
h	0,010	0,015	0,020
θ	0°	4°	8°
θ_1	5°	10°	15°
θ_2	0°	—	—

UNIT : INCH

IMPORTANT NOTICE

DIODES INCORPORATED MAKES NO WARRANTY OF ANY KIND, EXPRESS OR IMPLIED, WITH REGARDS TO THIS DOCUMENT, INCLUDING, BUT NOT LIMITED TO, THE IMPLIED WARRANTIES OF MERCHANTABILITY AND FITNESS FOR A PARTICULAR PURPOSE (AND THEIR EQUIVALENTS UNDER THE LAWS OF ANY JURISDICTION).

Diodes Incorporated and its subsidiaries reserve the right to make modifications, enhancements, improvements, corrections or other changes without further notice to this document and any product described herein. Diodes Incorporated does not assume any liability arising out of the application or use of this document or any product described herein; neither does Diodes Incorporated convey any license under its patent or trademark rights, nor the rights of others. Any Customer or user of this document or products described herein in such applications shall assume all risks of such use and will agree to hold Diodes Incorporated and all the companies whose products are represented on Diodes Incorporated website, harmless against all damages.

Diodes Incorporated does not warrant or accept any liability whatsoever in respect of any products purchased through unauthorized sales channel. Should Customers purchase or use Diodes Incorporated products for any unintended or unauthorized application, Customers shall indemnify and hold Diodes Incorporated and its representatives harmless against all claims, damages, expenses, and attorney fees arising out of, directly or indirectly, any claim of personal injury or death associated with such unintended or unauthorized application.

Products described herein may be covered by one or more United States, international or foreign patents pending. Product names and markings noted herein may also be covered by one or more United States, international or foreign trademarks.

This document is written in English but may be translated into multiple languages for reference. Only the English version of this document is the final and determinative format released by Diodes Incorporated.

LIFE SUPPORT

Diodes Incorporated products are specifically not authorized for use as critical components in life support devices or systems without the express written approval of the Chief Executive Officer of Diodes Incorporated. As used herein:

A. Life support devices or systems are devices or systems which:

1. are intended to implant into the body, or
2. support or sustain life and whose failure to perform when properly used in accordance with instructions for use provided in the labeling can be reasonably expected to result in significant injury to the user.

B. A critical component is any component in a life support device or system whose failure to perform can be reasonably expected to cause the failure of the life support device or to affect its safety or effectiveness.

Customers represent that they have all necessary expertise in the safety and regulatory ramifications of their life support devices or systems, and acknowledge and agree that they are solely responsible for all legal, regulatory and safety-related requirements concerning their products and any use of Diodes Incorporated products in such safety-critical, life support devices or systems, notwithstanding any devices- or systems-related information or support that may be provided by Diodes Incorporated. Further, Customers must fully indemnify Diodes Incorporated and its representatives against any damages arising out of the use of Diodes Incorporated products in such safety-critical, life support devices or systems.

Copyright © 2012, Diodes Incorporated

www.diodes.com