



Is Now Part of



**ON Semiconductor®**

To learn more about ON Semiconductor, please visit our website at  
[www.onsemi.com](http://www.onsemi.com)

ON Semiconductor and the ON Semiconductor logo are trademarks of Semiconductor Components Industries, LLC dba ON Semiconductor or its subsidiaries in the United States and/or other countries. ON Semiconductor owns the rights to a number of patents, trademarks, copyrights, trade secrets, and other intellectual property. A listing of ON Semiconductor's product/patent coverage may be accessed at [www.onsemi.com/site/pdf/Patent-Marking.pdf](http://www.onsemi.com/site/pdf/Patent-Marking.pdf). ON Semiconductor reserves the right to make changes without further notice to any products herein. ON Semiconductor makes no warranty, representation or guarantee regarding the suitability of its products for any particular purpose, nor does ON Semiconductor assume any liability arising out of the application or use of any product or circuit, and specifically disclaims any and all liability, including without limitation special, consequential or incidental damages. Buyer is responsible for its products and applications using ON Semiconductor products, including compliance with all laws, regulations and safety requirements or standards, regardless of any support or applications information provided by ON Semiconductor. "Typical" parameters which may be provided in ON Semiconductor data sheets and/or specifications can and do vary in different applications and actual performance may vary over time. All operating parameters, including "Typicals" must be validated for each customer application by customer's technical experts. ON Semiconductor does not convey any license under its patent rights nor the rights of others. ON Semiconductor products are not designed, intended, or authorized for use as a critical component in life support systems or any FDA Class 3 medical devices or medical devices with a same or similar classification in a foreign jurisdiction or any devices intended for implantation in the human body. Should Buyer purchase or use ON Semiconductor products for any such unintended or unauthorized application, Buyer shall indemnify and hold ON Semiconductor and its officers, employees, subsidiaries, affiliates, and distributors harmless against all claims, costs, damages, and expenses, and reasonable attorney fees arising out of, directly or indirectly, any claim of personal injury or death associated with such unintended or unauthorized use, even if such claim alleges that ON Semiconductor was negligent regarding the design or manufacture of the part. ON Semiconductor is an Equal Opportunity/Affirmative Action Employer. This literature is subject to all applicable copyright laws and is not for resale in any manner.



February 2015

# FGH75T65SHD

## 650 V, 75 A Field Stop Trench IGBT

### Features

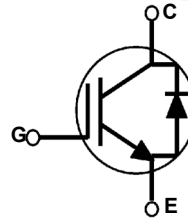
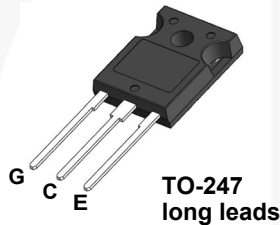
- Maximum Junction Temperature:  $T_J = 175^\circ\text{C}$
- Positive Temperature Co-efficient for Easy Parallel Operating
- High Current Capability
- Low Saturation Voltage:  $V_{CE(sat)} = 1.6\text{ V (Typ.) @ } I_C = 75\text{ A}$
- 100% of the Parts Tested for  $I_{LM}(1)$
- High Input Impedance
- Fast Switching
- Tighten Parameter Distribution
- RoHS Compliant

### General Description

Using novel field stop IGBT technology, Fairchild's new series of field stop 3<sup>rd</sup> generation IGBTs offer the optimum performance for solar inverter, UPS, welder, telecom, ESS and PFC applications where low conduction and switching losses are essential.

### Applications

- Solar Inverter, UPS, Welder, Telecom, ESS, PFC



### Absolute Maximum Ratings $T_C = 25^\circ\text{C}$ unless otherwise noted

| Symbol      | Description   | FGH75T65SHD_F155 | Unit             |
|-------------|---|------------------|------------------|
| $V_{CES}$   | Collector to Emitter Voltage  | 650              | V                |
| $V_{GES}$   | Gate to Emitter Voltage   | $\pm 20$         | V                |
|             | Transient Gate to Emitter Voltage                                       | $\pm 30$         | V                |
| $I_C$       | Collector Current @ $T_C = 25^\circ\text{C}$                            | 150              | A                |
|             | Collector Current @ $T_C = 100^\circ\text{C}$                           | 75               | A                |
| $I_{LM}(1)$ | Pulsed Collector Current @ $T_C = 25^\circ\text{C}$                     | 225              | A                |
| $I_{CM}(2)$ | Pulsed Collector Current  | 225              | A                |
| $I_F$       | Diode Forward Current @ $T_C = 25^\circ\text{C}$                        | 75               | A                |
|             | Diode Forward Current @ $T_C = 100^\circ\text{C}$                       | 50               | A                |
| $I_{FM}(2)$ | Pulsed Diode Maximum Forward Current                                    | 225              | A                |
| $P_D$       | Maximum Power Dissipation @ $T_C = 25^\circ\text{C}$                    | 455              | W                |
|             | Maximum Power Dissipation @ $T_C = 100^\circ\text{C}$                   | 227              | W                |
| $T_J$       | Operating Junction Temperature  | -55 to +175      | $^\circ\text{C}$ |
| $T_{stg}$   | Storage Temperature Range   | -55 to +175      | $^\circ\text{C}$ |
| $T_L$       | Maximum Lead Temp. for soldering Purposes, 1/8" from case for 5 seconds | 300              | $^\circ\text{C}$ |

**Notes:**

1.  $V_{CC} = 400\text{ V}$ ,  $V_{GE} = 15\text{ V}$ ,  $I_C = 225\text{ A}$ ,  $R_G = 20\ \Omega$ , Inductive Load
2. Repetitive rating: Pulse width limited by max. junction temperature

FGH75T65SHD 650 V, 75 A Field Stop Trench IGBT

## Thermal Characteristics

| Symbol                  | Parameter                                     | FGH75T65SHD_F155 | Unit                        |
|-------------------------|---|------------------|-----------------------------|
| $R_{\theta JC}$ (IGBT)  | Thermal Resistance, Junction to Case, Max.    | 0.33             | $^{\circ}\text{C}/\text{W}$ |
| $R_{\theta JC}$ (Diode) | Thermal Resistance, Junction to Case, Max.    | 0.65             | $^{\circ}\text{C}/\text{W}$ |
| $R_{\theta JA}$         | Thermal Resistance, Junction to Ambient, Max. | 40               | $^{\circ}\text{C}/\text{W}$ |

## Package Marking and Ordering Information

| Part Number      | Top Mark    | Package    | Packing Method | Reel Size | Tape Width | Quantity |
|------------------|-------------|------------|----------------|-----------|------------|----------|
| FGH75T65SHD_F155 | FGH75T65SHD | TO-247 G03 | Tube           | -         | -          | 30       |

## Electrical Characteristics of the IGBT $T_C = 25^{\circ}\text{C}$ unless otherwise noted

| Symbol                           | Parameter                                    | Test Conditions  | Min. | Typ. | Max.      | Unit                        |
|----------------------------------|--|--|------|------|-----------|-----------------------------|
| <b>Off Characteristics</b>       |  |  |      |      |           |                             |
| $BV_{CES}$                       | Collector to Emitter Breakdown Voltage       | $V_{GE} = 0\text{V}, I_C = 1\text{mA}$   | 650  | -    | -         | V                           |
| $\Delta BV_{CES} / \Delta T_J$   | Temperature Coefficient of Breakdown Voltage | $I_C = 1\text{mA}$ , Reference to $25^{\circ}\text{C}$   | -    | 0.6  | -         | $\text{V}/^{\circ}\text{C}$ |
| $I_{CES}$                        | Collector Cut-Off Current                    | $V_{CE} = V_{CES}, V_{GE} = 0\text{V}$   | -    | -    | 250       | $\mu\text{A}$               |
| $I_{GES}$                        | G-E Leakage Current                          | $V_{GE} = V_{GES}, V_{CE} = 0\text{V}$   | -    | -    | $\pm 400$ | nA                          |
| <b>On Characteristics</b>        |  |  |      |      |           |                             |
| $V_{GE(th)}$                     | G-E Threshold Voltage                        | $I_C = 75\text{mA}, V_{CE} = V_{GE}$   | 4.0  | 5.5  | 7.5       | V                           |
| $V_{CE(sat)}$                    | Collector to Emitter Saturation Voltage      | $I_C = 75\text{A}, V_{GE} = 15\text{V}$  | -    | 1.6  | 2.1       | V                           |
|                                  |  | $I_C = 75\text{A}, V_{GE} = 15\text{V}, T_C = 175^{\circ}\text{C}$   | -    | 2.28 | -         | V                           |
| <b>Dynamic Characteristics</b>   |  |  |      |      |           |                             |
| $C_{ies}$                        | Input Capacitance                            | $V_{CE} = 30\text{V}, V_{GE} = 0\text{V}, f = 1\text{MHz}$   | -    | 3680 | -         | pF                          |
| $C_{oes}$                        | Output Capacitance                           |  | -    | 179  | -         | pF                          |
| $C_{res}$                        | Reverse Transfer Capacitance                 |  | -    | 43   | -         | pF                          |
| <b>Switching Characteristics</b> |  |  |      |      |           |                             |
| $t_{d(on)}$                      | Turn-On Delay Time                           | $V_{CC} = 400\text{V}, I_C = 75\text{A}, R_G = 3\Omega, V_{GE} = 15\text{V},$<br>Inductive Load, $T_C = 25^{\circ}\text{C}$  | -    | 28   | -         | ns                          |
| $t_r$                            | Rise Time                                    |  | -    | 56   | -         | ns                          |
| $t_{d(off)}$                     | Turn-Off Delay Time                          |  | -    | 80   | -         | ns                          |
| $t_f$                            | Fall Time                                    |  | -    | 14.4 | -         | ns                          |
| $E_{on}$                         | Turn-On Switching Loss                       |  | -    | 2.4  | -         | mJ                          |
| $E_{off}$                        | Turn-Off Switching Loss                      |  | -    | 0.72 | -         | mJ                          |
| $E_{ts}$                         | Total Switching Loss                         |  | -    | 3.12 | -         | mJ                          |
| $t_{d(on)}$                      | Turn-On Delay Time                           | $V_{CC} = 400\text{V}, I_C = 75\text{A}, R_G = 3\Omega, V_{GE} = 15\text{V},$<br>Inductive Load, $T_C = 175^{\circ}\text{C}$ | -    | 26.4 | -         | ns                          |
| $t_r$                            | Rise Time                                    |  | -    | 58.4 | -         | ns                          |
| $t_{d(off)}$                     | Turn-Off Delay Time                          |  | -    | 86.4 | -         | ns                          |
| $t_f$                            | Fall Time                                    |  | -    | 13.6 | -         | ns                          |
| $E_{on}$                         | Turn-On Switching Loss                       |  | -    | 3.7  | -         | mJ                          |
| $E_{off}$                        | Turn-Off Switching Loss                      |  | -    | 0.98 | -         | mJ                          |
| $E_{ts}$                         | Total Switching Loss                         |  | -    | 4.68 | -         | mJ                          |

**Electrical Characteristics of the IGBT** (Continued)

| Symbol   | Parameter                | Test Conditions   | Min. | Typ. | Max | Unit |
|----------|--------------------------|---|------|------|-----|------|
| $Q_g$    | Total Gate Charge        | $V_{CE} = 400\text{ V}$ , $I_C = 75\text{ A}$ ,<br>$V_{GE} = 15\text{ V}$ | -    | 123  | -   | nC   |
| $Q_{ge}$ | Gate to Emitter Charge   |   | -    | 22.6 | -   | nC   |
| $Q_{gc}$ | Gate to Collector Charge |   | -    | 44.9 | -   | nC   |

**Electrical Characteristics of the Diode**  $T_C = 25^\circ\text{C}$  unless otherwise noted

| Symbol    | Parameter                     | Test Conditions  | Min.                      | Typ. | Max  | Unit |               |
|-----------|-------------------------------|--|---------------------------|------|------|------|---------------|
| $V_{FM}$  | Diode Forward Voltage         | $I_F = 50\text{ A}$  | $T_C = 25^\circ\text{C}$  | -    | 2.2  | 2.7  | V             |
|           |                               |  | $T_C = 175^\circ\text{C}$ | -    | 1.8  | -    |               |
| $E_{rec}$ | Reverse Recovery Energy       | $I_F = 50\text{ A}$ , $dI_F/dt = 200\text{ A}/\mu\text{s}$ | $T_C = 175^\circ\text{C}$ | -    | 60   | -    | $\mu\text{J}$ |
| $t_{rr}$  | Diode Reverse Recovery Time   |  | $T_C = 25^\circ\text{C}$  | -    | 43.4 | -    | ns            |
|           |                               |  | $T_C = 175^\circ\text{C}$ | -    | 207  | -    |               |
| $Q_{rr}$  | Diode Reverse Recovery Charge |  | $T_C = 25^\circ\text{C}$  | -    | 87.9 | -    | nC            |
|           |                               | $T_C = 175^\circ\text{C}$                                  | -                         | 1243 | -    |      |               |

## Typical Performance Characteristics

Figure 1. Typical Output Characteristics

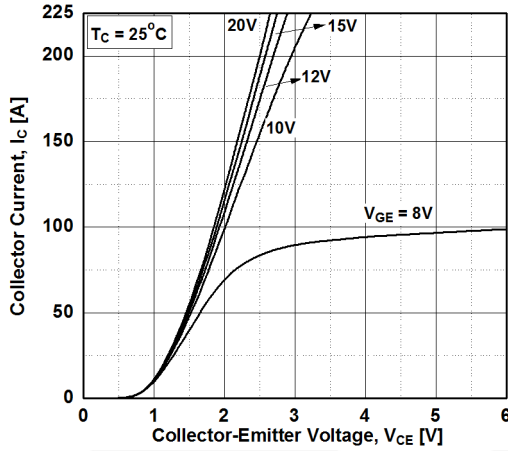


Figure 2. Typical Output Characteristics

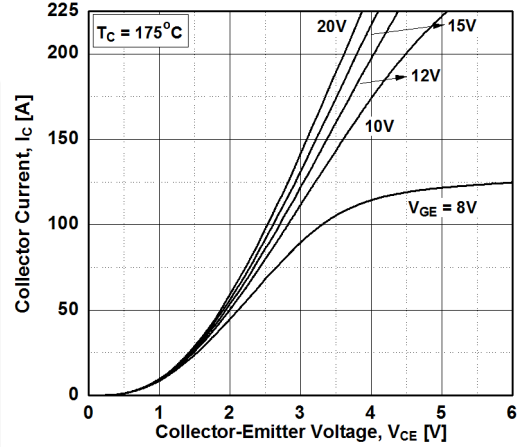


Figure 3. Typical Saturation Voltage Characteristics

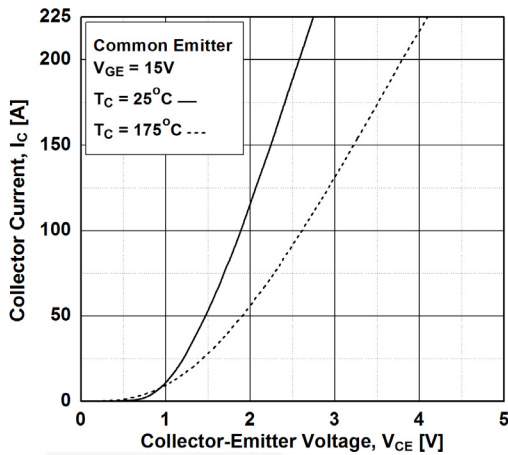


Figure 4. Saturation Voltage vs. Case Temperature at Variant Current Level

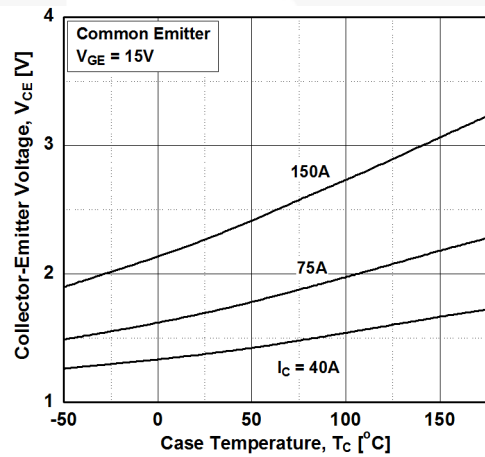


Figure 5. Saturation Voltage vs.  $V_{GE}$

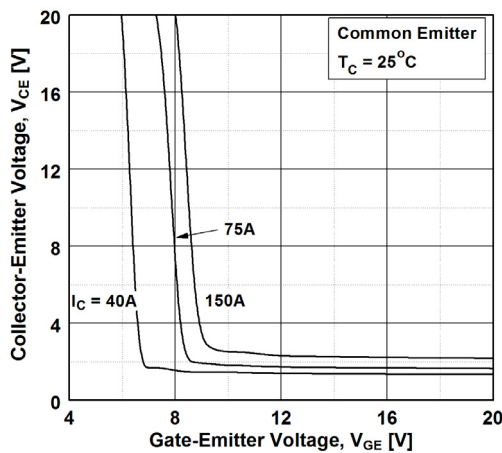
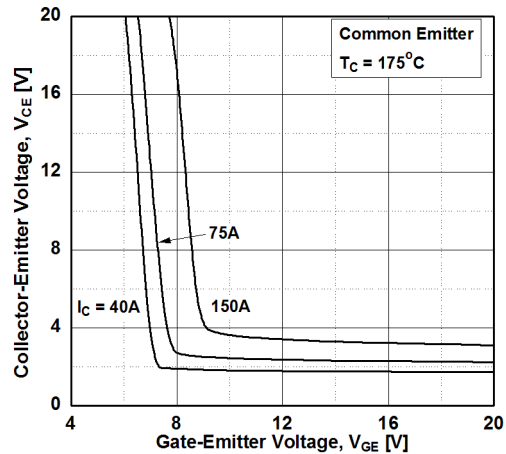
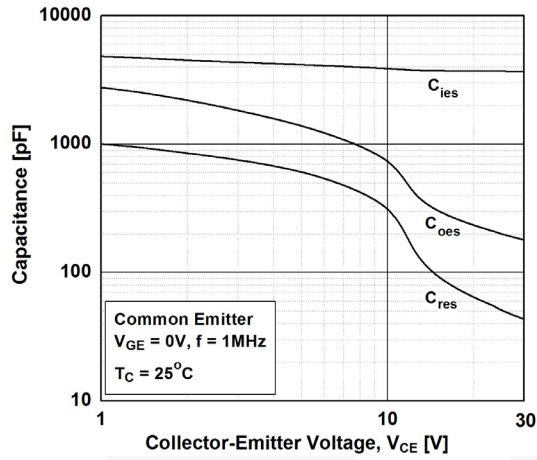


Figure 6. Saturation Voltage vs.  $V_{GE}$

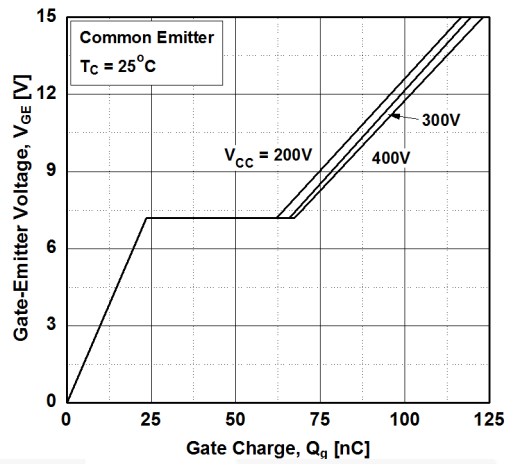


## Typical Performance Characteristics

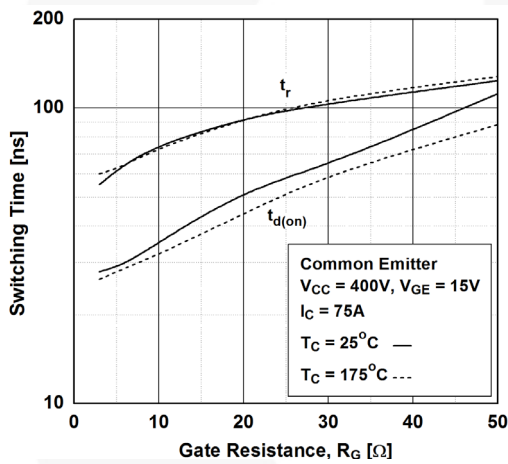
**Figure 7. Capacitance Characteristics**



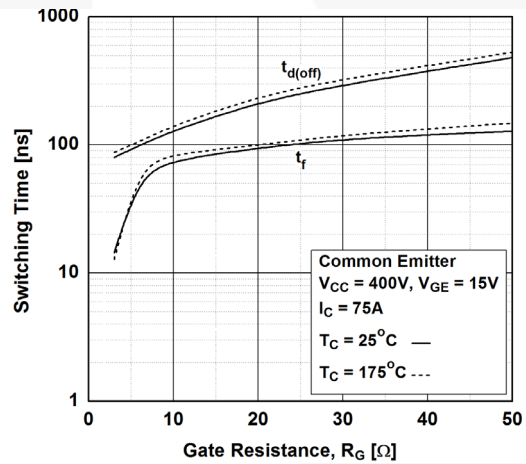
**Figure 8. Gate charge Characteristics**



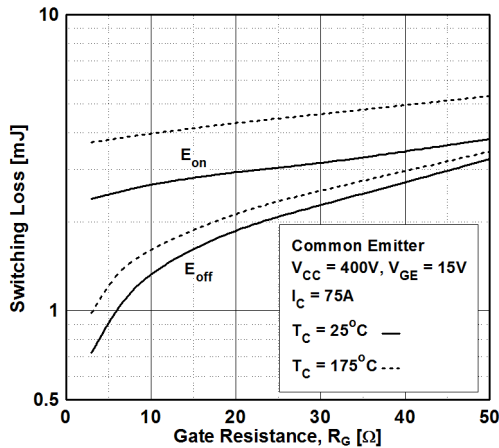
**Figure 9. Turn-on Characteristics vs. Gate Resistance**



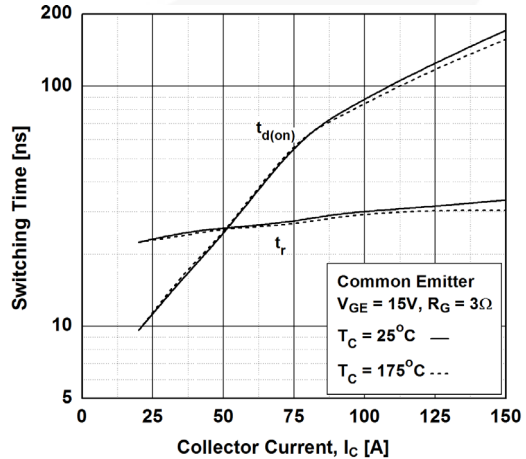
**Figure 10. Turn-off Characteristics vs. Gate Resistance**



**Figure 11. Switching Loss vs. Gate Resistance**

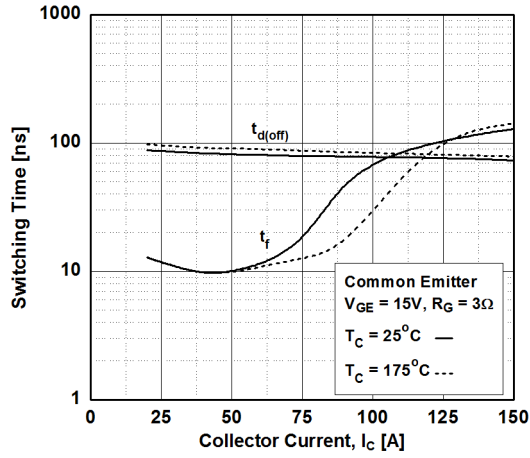


**Figure 12. Turn-on Characteristics vs. Collector Current**

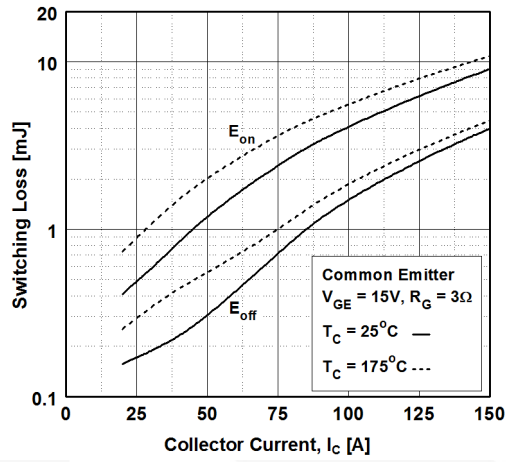


## Typical Performance Characteristics

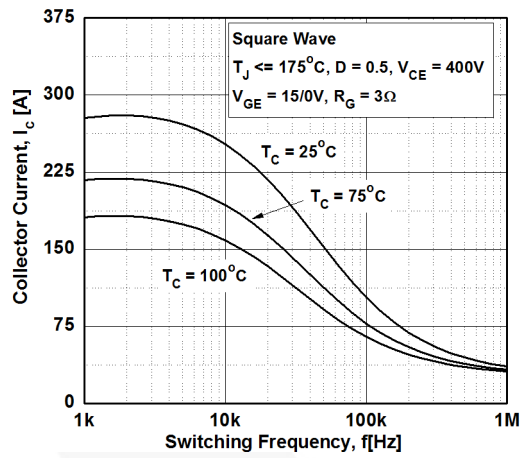
**Figure 13. Turn-off Characteristics vs. Collector Current**



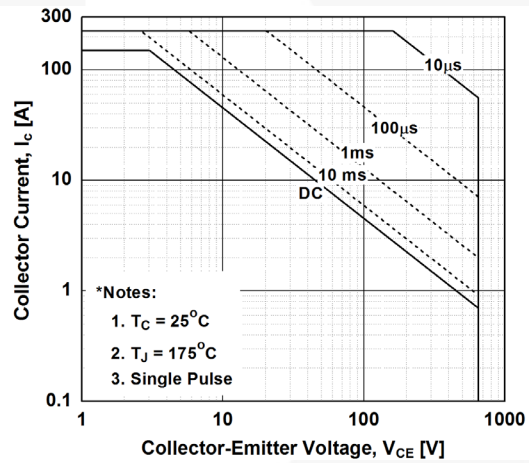
**Figure 14. Switching Loss vs. Collector Current**



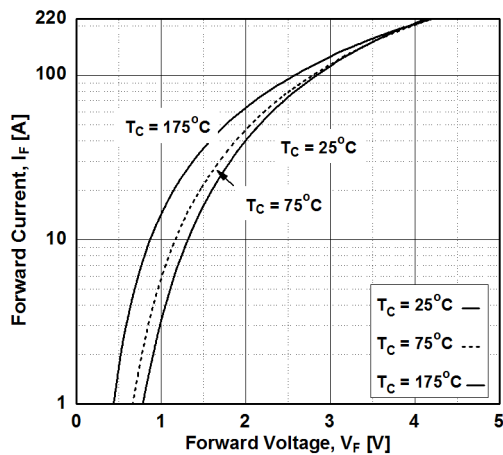
**Figure 15. Load Current Vs. Frequency**



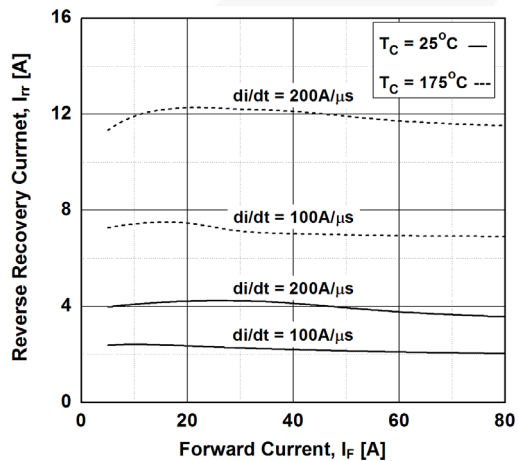
**Figure 16. SOA Characteristics**



**Figure 17. Forward Characteristics**



**Figure 18. Reverse Recovery Current**



## Typical Performance Characteristics

Figure 19. Reverse Recovery Time

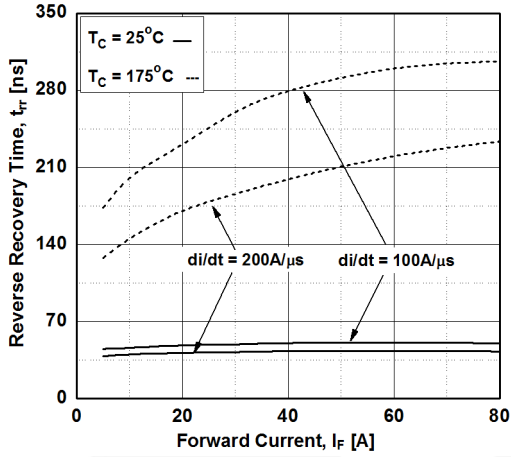


Figure 20. Stored Charge

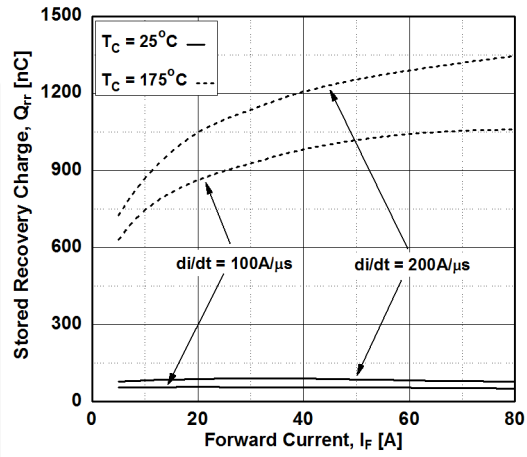


Figure 21. Transient Thermal Impedance of IGBT

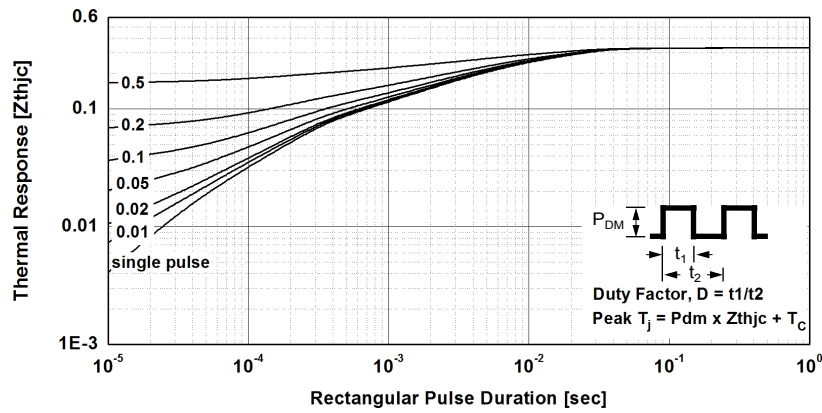
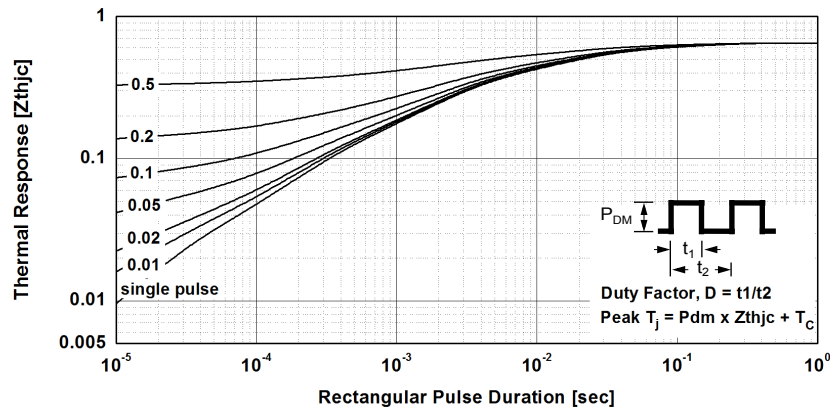
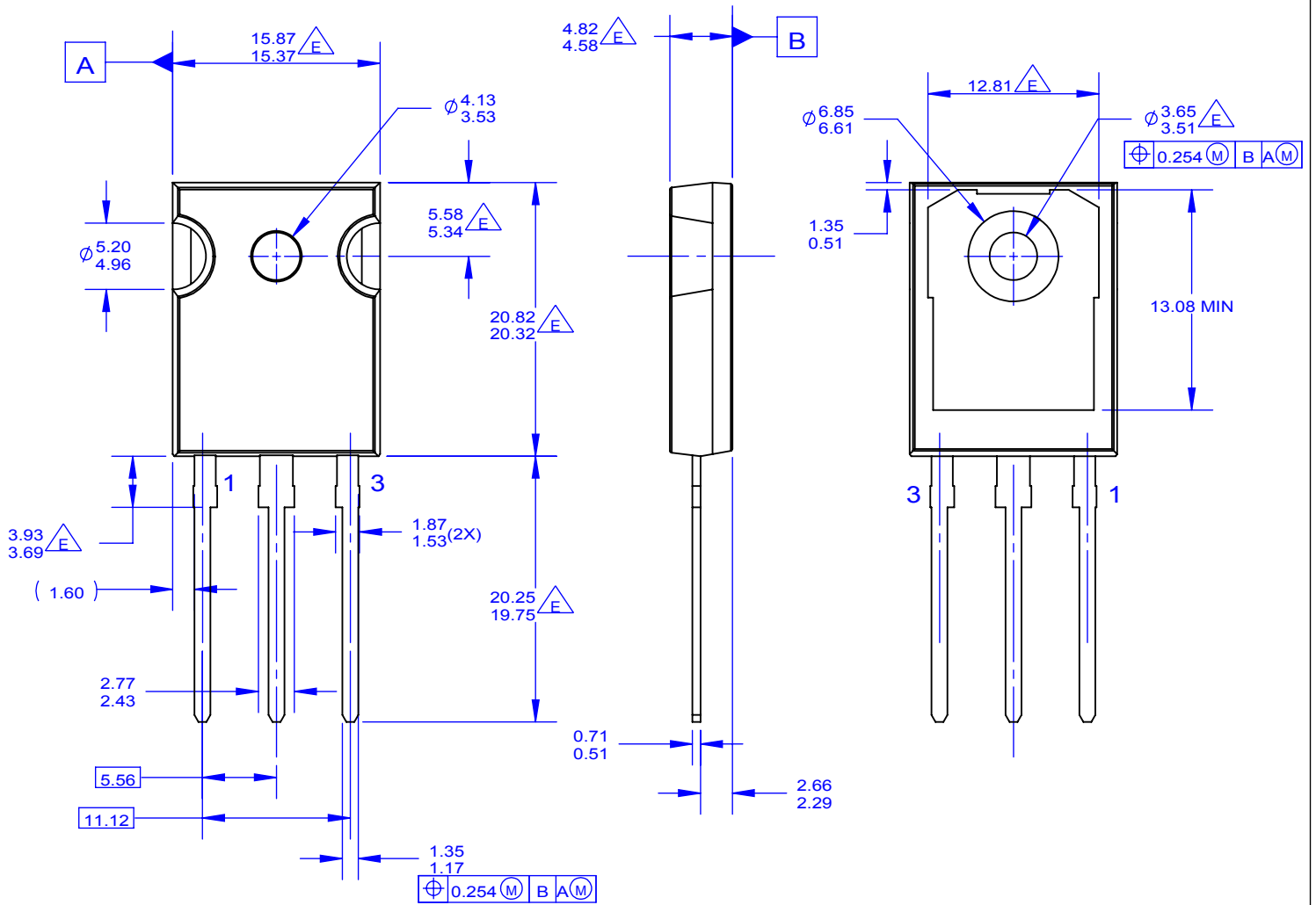


Figure 22. Transient Thermal Impedance of Diode







NOTES: UNLESS OTHERWISE SPECIFIED.

- A. PACKAGE REFERENCE: JEDEC TO-247, ISSUE E, VARIATION AB, DATED JUNE, 2004.
- B. DIMENSIONS ARE EXCLUSIVE OF BURRS, MOLD FLASH, AND TIE BAR EXTRUSIONS.
- C. ALL DIMENSIONS ARE IN MILLIMETERS.
- D. DRAWING CONFORMS TO ASME Y14.5 - 1994

$\triangle$  E DOES NOT COMPLY JEDEC STANDARD VALUE  
 F. DRAWING FILENAME: MKT-TO247G03\_REV02



ON Semiconductor and  are trademarks of Semiconductor Components Industries, LLC dba ON Semiconductor or its subsidiaries in the United States and/or other countries. ON Semiconductor owns the rights to a number of patents, trademarks, copyrights, trade secrets, and other intellectual property. A listing of ON Semiconductor's product/patent coverage may be accessed at [www.onsemi.com/site/pdf/Patent-Marking.pdf](http://www.onsemi.com/site/pdf/Patent-Marking.pdf). ON Semiconductor reserves the right to make changes without further notice to any products herein. ON Semiconductor makes no warranty, representation or guarantee regarding the suitability of its products for any particular purpose, nor does ON Semiconductor assume any liability arising out of the application or use of any product or circuit, and specifically disclaims any and all liability, including without limitation special, consequential or incidental damages. Buyer is responsible for its products and applications using ON Semiconductor products, including compliance with all laws, regulations and safety requirements or standards, regardless of any support or applications information provided by ON Semiconductor. "Typical" parameters which may be provided in ON Semiconductor data sheets and/or specifications can and do vary in different applications and actual performance may vary over time. All operating parameters, including "Typicals" must be validated for each customer application by customer's technical experts. ON Semiconductor does not convey any license under its patent rights nor the rights of others. ON Semiconductor products are not designed, intended, or authorized for use as a critical component in life support systems or any FDA Class 3 medical devices or medical devices with a same or similar classification in a foreign jurisdiction or any devices intended for implantation in the human body. Should Buyer purchase or use ON Semiconductor products for any such unintended or unauthorized application, Buyer shall indemnify and hold ON Semiconductor and its officers, employees, subsidiaries, affiliates, and distributors harmless against all claims, costs, damages, and expenses, and reasonable attorney fees arising out of, directly or indirectly, any claim of personal injury or death associated with such unintended or unauthorized use, even if such claim alleges that ON Semiconductor was negligent regarding the design or manufacture of the part. ON Semiconductor is an Equal Opportunity/Affirmative Action Employer. This literature is subject to all applicable copyright laws and is not for resale in any manner.

## PUBLICATION ORDERING INFORMATION

### LITERATURE FULFILLMENT:

Literature Distribution Center for ON Semiconductor  
19521 E. 32nd Pkwy, Aurora, Colorado 80011 USA  
**Phone:** 303-675-2175 or 800-344-3860 Toll Free USA/Canada  
**Fax:** 303-675-2176 or 800-344-3867 Toll Free USA/Canada  
**Email:** [orderlit@onsemi.com](mailto:orderlit@onsemi.com)

**N. American Technical Support:** 800-282-9855 Toll Free  
USA/Canada  
**Europe, Middle East and Africa Technical Support:**  
Phone: 421 33 790 2910  
**Japan Customer Focus Center**  
Phone: 81-3-5817-1050

**ON Semiconductor Website:** [www.onsemi.com](http://www.onsemi.com)  
**Order Literature:** <http://www.onsemi.com/orderlit>  
For additional information, please contact your local  
Sales Representative