

## MAX9611PMB1 Peripheral Module

### General Description

The MAX9611PMB1 peripheral module provides the necessary hardware to interface the MAX9611 current-sense amplifier with 12-bit ADC and op amp, along with the MAX5380 8-bit DAC, to any system that utilizes Pmod™-compatible expansion ports configurable for I<sup>2</sup>C communication. The IC is configured with an external p-channel FET and a current-sense resistor to form a current-limiting circuit capable of handling currents up to 1A. An 8-bit DAC (U1) is used to set the current-limit point programmatically by the host through the I<sup>2</sup>C bus. In addition to providing a programmable current-limit function, the ADC within the IC measures the load current/voltage and the set-point voltage that can be read by the host through the I<sup>2</sup>C bus.

Refer to the MAX9611 IC data sheet for detailed information regarding operation of the IC.

### Features

- ◆ Programmable Current Limit Up to 1A
- ◆ Two Current Ranges (Jumper Selectable)
- ◆ Measure and Read Back Load Current, Load Voltage, and Set Point
- ◆ Power Source Up to 30V
- ◆ Jumper-Selectable I<sup>2</sup>C Address Setting for the MAX9611
- ◆ 6-Pin Pmod-Compatible Connector (I<sup>2</sup>C)
- ◆ Secondary Header Allows Daisy-Chaining of Additional Modules on the I<sup>2</sup>C Bus
- ◆ Example Software Written in C for Portability
- ◆ RoHS Compliant
- ◆ Proven PCB Layout
- ◆ Fully Assembled and Tested

*Ordering Information* appears at end of data sheet.

### MAX9611PMB1 Peripheral Module

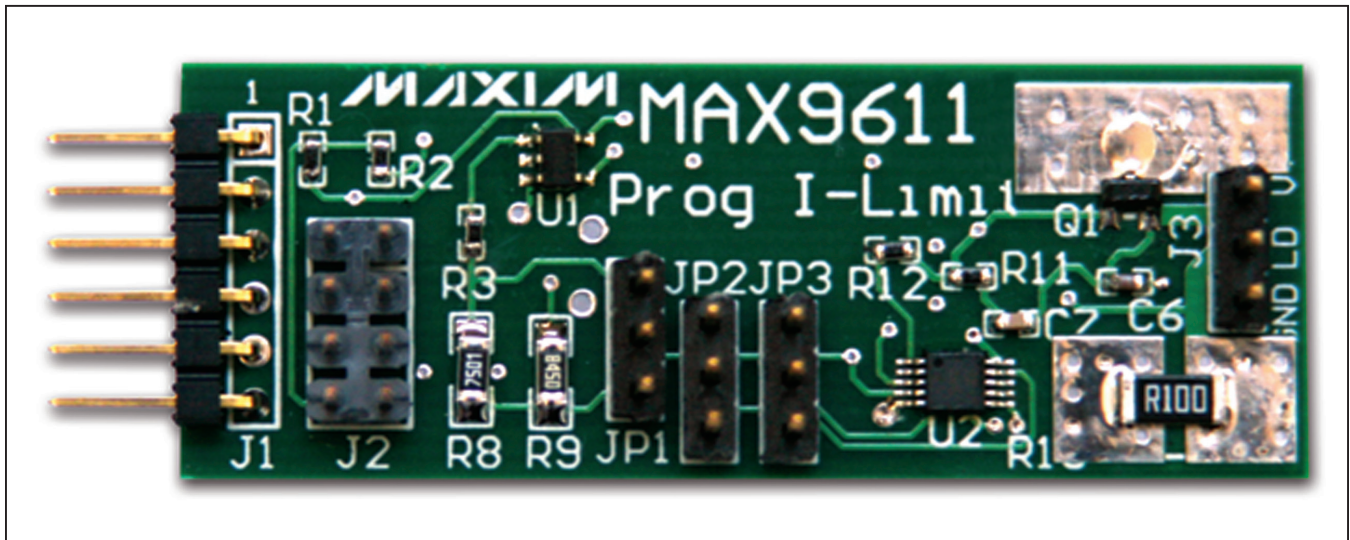

*Pmod is a trademark of Digilent Inc.*

# MAX9611PMB1 Peripheral Module

## Component List

DESIGNATION	QTY	DESCRIPTION
C1, C2, C3	3	0.1 $\mu$ F $\pm$ 10%, 16V X7R ceramic capacitors (0603) Murata GRM188R71C104KA01D
C4	1	4.7 $\mu$ F $\pm$ 10%, 10V X5R ceramic capacitor (0603) TDK C2012X5R1A475K/0.85
C5	1	10 $\mu$ F $\pm$ 10%, 10V X5R ceramic capacitor (0603) TDK C2012X5R1A106K/1.25
C6	1	1 $\mu$ F $\pm$ 10%, 10V X7R ceramic capacitor (0603) TDK C1608X7R1A105K
C7	1	0.01 $\mu$ F $\pm$ 10%, 16V X7R ceramic capacitor (0603) Murata GRM188R71C103KA01D
F1	1	4.7 $\mu$ F EMI filter (3-terminal capacitor) Murata NFM21PC475B1A3D
J1	1	6-pin right-angle male header
J2	1	8-pin (2 x 4) straight male header
J3, JP1, JP2, JP3	4	3-pin straight male headers

DESIGNATION	QTY	DESCRIPTION
Q1	1	2.2A, 30V p-channel MOSFET (3 SOT23) Vishay Si2303CDS
R1–R5	5	4.7k $\Omega$ $\pm$ 1% resistors (0603)
R6, R7	2	150 $\Omega$ $\pm$ 5% resistors (0603)
R8	1	7.5k $\Omega$ $\pm$ 1% resistor (1206)
R9	1	845 $\Omega$ $\pm$ 1% resistor (1206)
R10	1	4.02k $\Omega$ $\pm$ 1% resistor (0603)
R11	1	402 $\Omega$ $\pm$ 1% resistor (0603)
R12	1	8.06k $\Omega$ $\pm$ 1% resistor (0603)
R13	1	0.2 $\Omega$ $\pm$ 1%, 2W current-sense resistor (2512) Stackpole CSRN2512FKR200
R14, R15	2	10k $\Omega$ $\pm$ 5% resistors (0603)
U1	1	Low-cost, 8-bit DAC (5 SOT23) Maxim MAX5380MEUK+
U2	1	Current-sense amplifier with 12-bit ADC (10 $\mu$ MAX <sup>®</sup> ) Maxim MAX9611AUB+
—	3	Shorting jumpers
—	1	PCB: EPCB9611PM1

## Component Suppliers

SUPPLIER	PHONE	WEBSITE
Murata Electronics North America, Inc.	770-436-1300	www.murata-northamerica.com
TDK Corp.	847-803-6100	www.component.tdk.com
Vishay	402-563-6866	www.vishay.com

**Note:** Indicate that you are using the MAX9611PMB1 when contacting these component suppliers.

## Detailed Description

### I<sup>2</sup>C Interface

The MAX9611PMB1 peripheral module can interface to the host in one of two ways. It can plug directly into a Pmod-compatible port (configured for I<sup>2</sup>C) through connector J1, or in this case, other I<sup>2</sup>C boards can attach to the same I<sup>2</sup>C bus through connector J2.

### I<sup>2</sup>C Interface (Daisy-Chaining Modules)

Alternatively, the peripheral module can connect to other I<sup>2</sup>C-based Pmod modules using a 4-conductor ribbon cable connecting to the J2 connector. In this situation, pins 1-4 and 5-8 on J2 provide two connections to the I<sup>2</sup>C bus, allowing the module to be inserted into an I<sup>2</sup>C bus daisy-chain.

$\mu$ MAX is a registered trademark of Maxim Integrated Products, Inc.

**Table 1. Connector J1 (I<sup>2</sup>C Communication)**

PIN	SIGNAL	DESCRIPTION
1	N.C.	Not connected
2	N.C.	Not connected
3	SCL	I <sup>2</sup> C serial clock
4	SDA	I <sup>2</sup> C serial data
5	GND	Ground
6	VCC	Power supply

Connector J1 provides connection of the module to the Pmod host. The pin assignments and functions adhere to the Pmod standard recommended by Digilent. See Table 1.

# MAX9611PMB1 Peripheral Module

Connector J2 allows the module to be connected through a daisy-chain from another I<sup>2</sup>C module and/or provide I<sup>2</sup>C and power connections to other I<sup>2</sup>C modules on the same bus. See Table 2.

## I<sup>2</sup>C Addressing Options

Both the MAX5380M and MAX9611 reside on the I<sup>2</sup>C bus. The MAX5380M has a fixed I<sup>2</sup>C slave address of 0x62 (other versions of the MAX5380 are available with different I<sup>2</sup>C slave addresses). The I<sup>2</sup>C slave address for the MAX9611 can be one of nine different values depending on the settings on jumpers JP2 and JP3. Table 3 lists the settings of those jumpers and the corresponding values of the slave read and write address. Refer to the MAX9611/MAX9612 IC data sheet for more information.

**Table 2. Connector J2 (I<sup>2</sup>C Expansion)**

PIN	SIGNAL	DESCRIPTION
1	SCL	I <sup>2</sup> C serial clock
2	SDA	I <sup>2</sup> C serial data
3	GND	Ground
4	VCC	Power supply
5	SCL	I <sup>2</sup> C serial clock
6	SDA	I <sup>2</sup> C serial data
7	GND	Ground
8	VCC	Power supply

**Table 3. I<sup>2</sup>C Slave Addresses (MAX9611)**

JP2 (A0)	JP3 (A1)	DEVICE ADDRESS (hex)	
		WRITE	READ
1-2	1-2	0xE0	0xE1
1-2	2-3	0xE4	0xE5
1-2	Open	0xE6	0xE7
2-3	1-2	0xF0	0xF1
2-3	2-3	0xF4	0xF5
2-3	Open	0xF6	0xF7
Open	1-2	0xF8	0xF9
Open	2-3	0xFC	0xFD
Open	Open	0xFE	0xFF

## Connecting an External Power Supply and Load

The peripheral module provides high-side current limiting for an external power supply and load. The supply and load should be connected to the peripheral module, as shown in Figure 1. Although the IC is capable of operation up to 60V, the **external supply should not exceed 30V** due to voltage limitations of the Si2303 pFET. While the pass components are rated to 2.7A, **operation above 1A may not yield reliable results** due to thermal limitations. Reliable operation of this circuit above 1A should be possible in the user's application if additional surface/heatsink area for both the Si2303 pFET and the 0.2Ω sense resistor is provided.

The J3 connector provides for the attachment of an external power supply and load. See Table 4.

**Table 4. Connector J3 (External Power and Load)**

PIN	SIGNAL	DESCRIPTION
1	Power source	This pin should be attached to the positive terminal of the external power supply. The external power source should be greater than 0V and less than 30V.
2	Load	This pin should be attached to a ground-referenced load.
3	Ground	External ground. This ground connection is referenced to the module ground on pin 5 of connector J1.

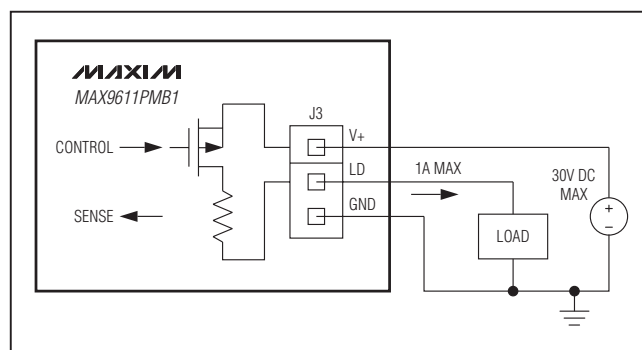

Figure 1. Connection of an External Power Supply and Load

# MAX9611PMB1 Peripheral Module

## Current Limit

The point at which current limiting begins is determined by the voltage at pin 4 on the MAX9611 ( $V_{SET}$ ). This voltage is set by the output of the DAC (MAX5380) and the setting of the shunt on JP1, which selects either  $V_{DAC}$  or  $V_{DAC}/10$ . The nominal 2.00V output of the DAC is divided to 1.26V full scale by the divider formed by R3 and R8 + R9. The lower tap of that divider (R3 + R8 and R9) provides 0.126V full scale. The position of the shunt on JP1 determines which of the two voltages is connected to  $V_{SET}$  on the MAX9611. With the shunt connected between JP1-1 and JP1-2, the higher voltage ( $V_{DAC}$ ) is connected to  $V_{SET}$ . This setting allows full-scale current limit at 2.56A with 10mA steps (**Caution:** Although software settings do not prohibit it, the circuit should not be operated above 1A output current as overheating and unreliable operation could result). When the shunt is connected between JP1-2 and JP1-3, the full-scale current is 256mA with 1mA steps.

**Important:** The total power dissipation for the pass FET (Q1) should not exceed 1.5W. This can easily be exceeded with even moderate output current if the load voltage is high and the load resistance is low.

The JP1 connector determines the current-limit range and step size. **Note:** Do not operate the board without a shunt in place, in one of these two positions. See Table 5.

**Table 5. Jumper JP1 (Current-Limit Range)**

SHUNT POSITION	$V_{SET}$	FULL-SCALE CURRENT LIMIT (A)	CURRENT-LIMIT STEP SIZE (mA)
1-2	$V_{DAC}$	2.56	10
2-3	$V_{DAC}/10$	0.256	1

## Software and FPGA Code

Example software and drivers are available that execute directly without modification on several FPGA development boards that support an integrated or synthesized microprocessor. These boards include the Digilent Nexys 3, Avnet LX9, and Avnet ZEDBoard, although other platforms can be added over time. Maxim provides complete Xilinx ISE projects containing HDL, Platform Studio, and SDK projects. In addition, a synthesized bit stream, ready for FPGA download, is provided for the demonstration application.

The software project (for the SDK) contains several source files intended to accelerate customer evaluation and design. These include a base application (maximModules.c) that demonstrates module functionality and uses an API interface (maximDeviceSpecificUtilities.c) to set and access Maxim device functions within a specific module.

The source code is written in standard ANSI C format, and all API documentation including theory/operation, register description, and function prototypes are documented in the API interface file (maximDeviceSpecificUtilities.h & .c).

The complete software kit is available for download at [www.maxim-ic.com](http://www.maxim-ic.com). Quick start instructions are also available as a separate document.



# MAX9611PMB1 Peripheral Module

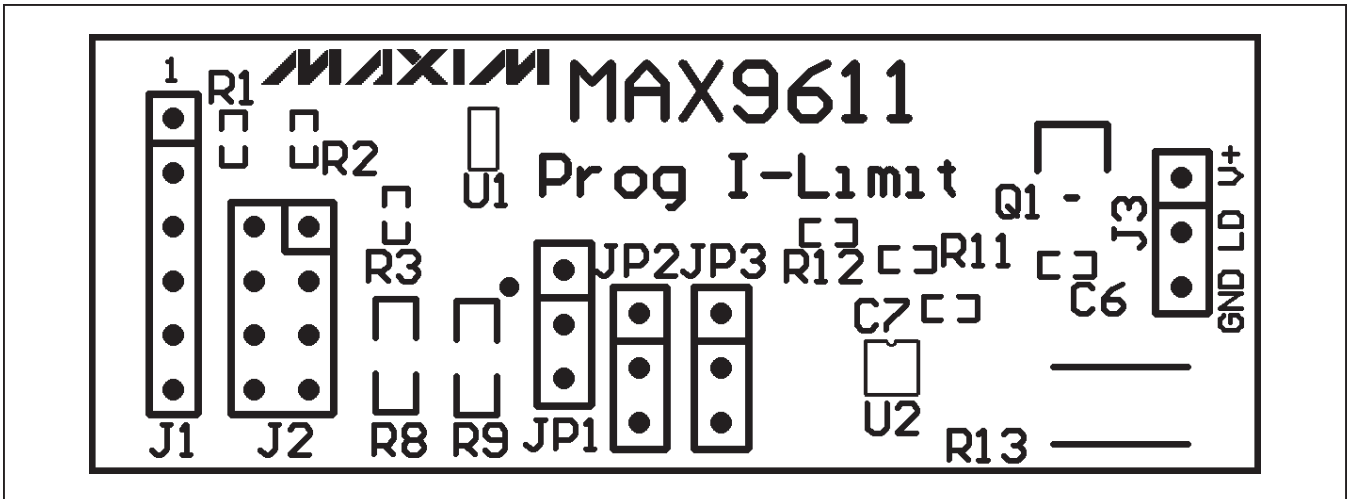

Figure 3. MAX9611PMB11 Peripheral Module Component Placement Guide—Component Side

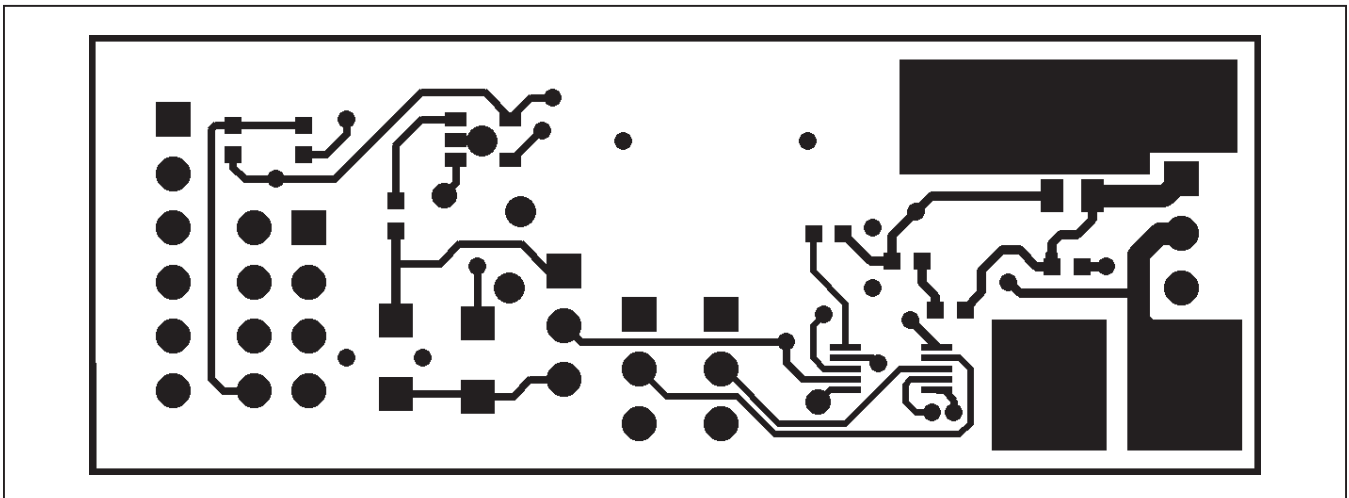

Figure 4. MAX9611PMB11 Peripheral Module PCB Layout—Component Side

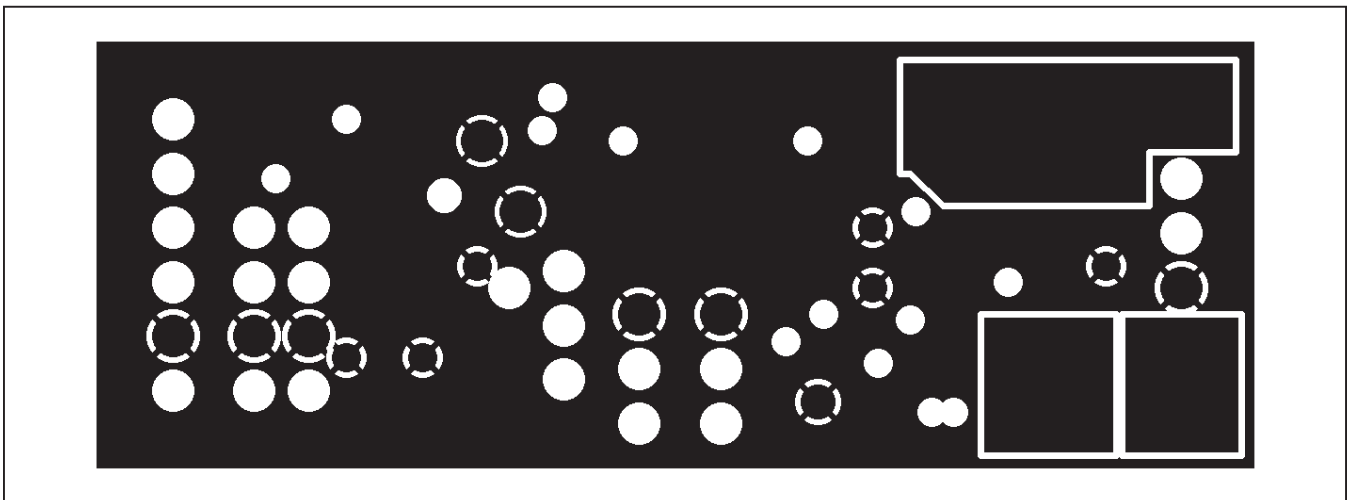

Figure 5. MAX9611PMB11 Peripheral Module PCB Layout—Inner Layer 1 (Ground)

# MAX9611PMB1 Peripheral Module

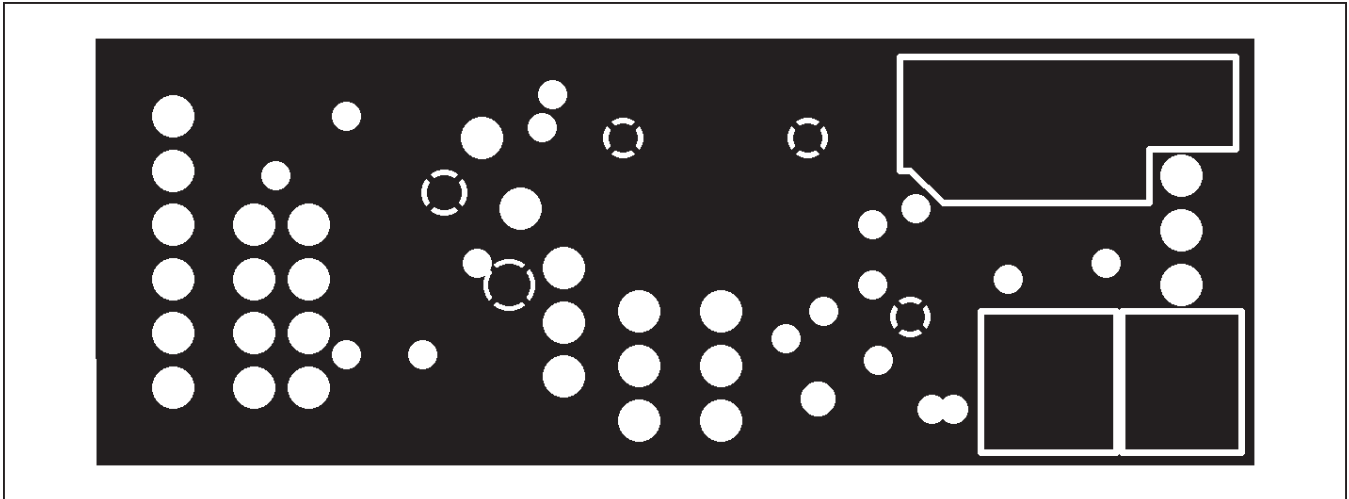

Figure 6. MAX9611PMB1 Peripheral Module PCB Layout—Inner Layer 2 (Power)

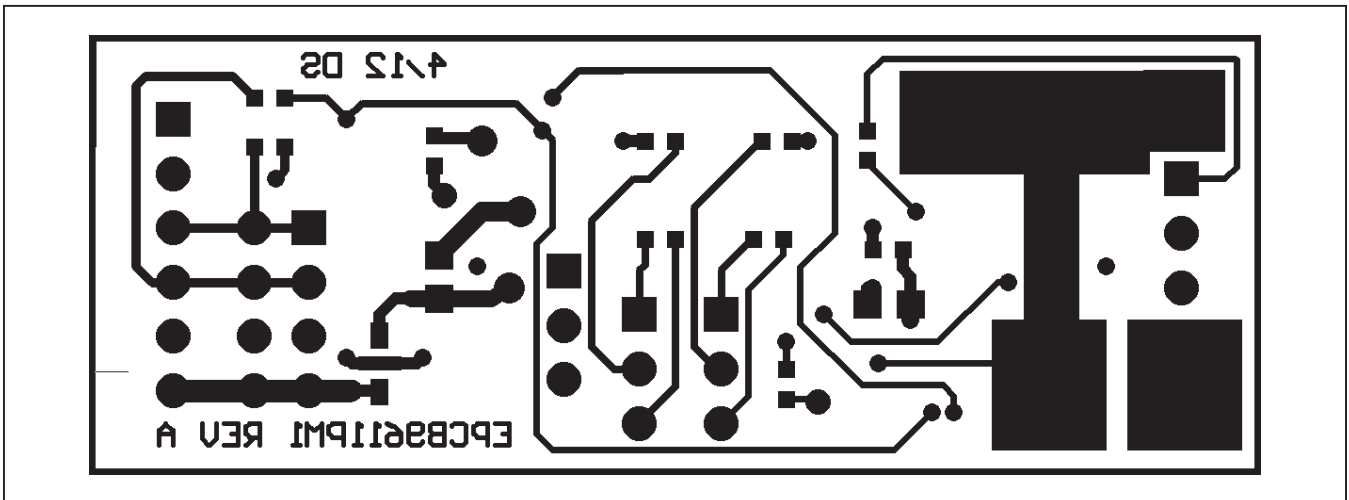

Figure 7. MAX9611PMB1 Peripheral Module PCB Layout—Solder Side

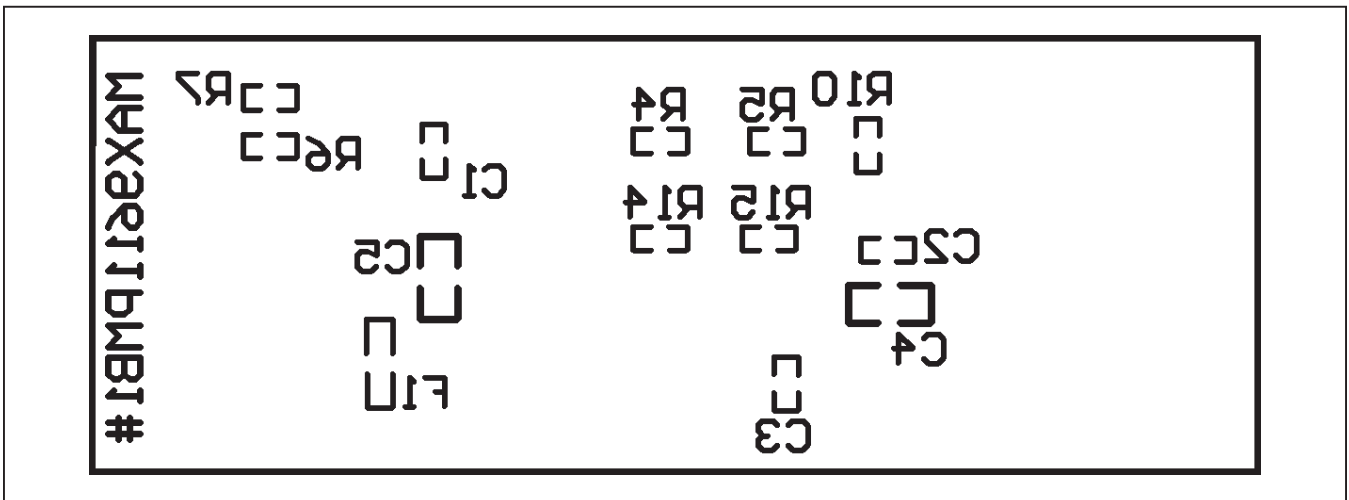

Figure 8. MAX9611PMB1 Peripheral Module Component Placement Guide—Solder Side

# MAX9611PMB1 Peripheral Module

## ***Ordering Information***

---

<b>PART</b>	<b>TYPE</b>
MAX9611PMB1#	Peripheral Module

#Denotes RoHS compliant.



# MAX9611PMB1 Peripheral Module

## Revision History

REVISION NUMBER	REVISION DATE	DESCRIPTION	PAGES CHANGED
0	5/12	Initial release	—

*Maxim cannot assume responsibility for use of any circuitry other than circuitry entirely embodied in a Maxim product. No circuit patent licenses are implied. Maxim reserves the right to change the circuitry and specifications without notice at any time.*

**Maxim Integrated Products, 120 San Gabriel Drive, Sunnyvale, CA 94086 408-737-7600 \_\_\_\_\_ 9**