

4

3

2

1

THIS DRAWING IS UNPUBLISHED.

RELEASED FOR PUBLICATION

20

© COPYRIGHT 20 BY -

ALL RIGHTS RESERVED.

REVISIONS

P	LTR	DESCRIPTION	DATE	DWN	APVD
	A	INITIAL	17APR2015	DW	CW
	B	ECR-15-018270	09DEC2015	DW	CW
	B1	ECR-16-018198	27DEC2016	QY	CW

TYPE-1:T2111020201-000 TE LOGO
 类型-1:T2111020201-000 TE LOGO

NOTES:

1. TECHNICAL CHARACTERISTICS:
 INSULATION MATERIAL: PC
 RATED VOLTAGE: 1000V
 RATED CURRENT: 70A
 INSULATION RESISTANCE: $\geq 400M\Omega$
 RATED IMPULSE VOLTAGE: 8KV
 POLLUTION DEGREE: 3
 FLAMMABILITY: UL94V-0
 MATING CYCLES: 500 CYCLES
 WIRE RANGE: 10~25 mm²
 CONTACT TYPE: CRIMP CONTACT

2. CONTACT NEED TO BE ORDERED SEPARATELY.
 (ORDER No. REFER TO DRAWING:T2400002XX0000)

注释:

1. 技术参数:
 绝缘材料: PC
 额定电压: 1000V
 额定电流: 70A
 绝缘电阻: $\geq 400M\Omega$
 额定脉冲电压: 8KV
 污染等级: 3
 阻燃等级: UL94V-0
 插拔次数: 500次
 接线范围: 10~25 mm²
 接线类型: 冷压接

2. 端子需要单独订购。
 (订货号参考图面: T2400002XX0000)

THIS DRAWING IS A CONTROLLED DOCUMENT.

DIMENSIONS:		TOLERANCES UNLESS OTHERWISE SPECIFIED:	
mm		0 PLC	±-
		1 PLC	±-
		2 PLC	±-
		3 PLC	±-
		4 PLC	±-
MATERIAL		ANGLES	±-
		FINISH	±-

DWN	17APR2015
David Wang	
CHK	17APR2015
Chris Wang	
APVD	17APR2015
Xiang Xu	
PRODUCT SPEC	108-137059
APPLICATION SPEC	114-137059
WEIGHT	-
Customer Drawing	

NAME		HMN-002-FC	
SIZE	CAGE CODE	DRAWING NO	RESTRICTED TO
A3	00779	©-T2111020201000	-
SCALE		SHEET	REV
3:2		1 OF 2	B1

1470-19 (3/13)

THIS DRAWING IS UNPUBLISHED.

RELEASED FOR PUBLICATION

20

© COPYRIGHT 20 BY -

ALL RIGHTS RESERVED.

REVISIONS

P	LTR	DESCRIPTION	DATE	DWN	APVD
-	-	SEE SHEET 1	-	-	-

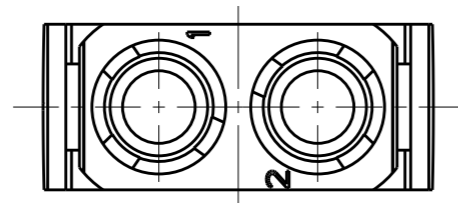

NOTES:
SEE SHEET 1
注释:
见页 1

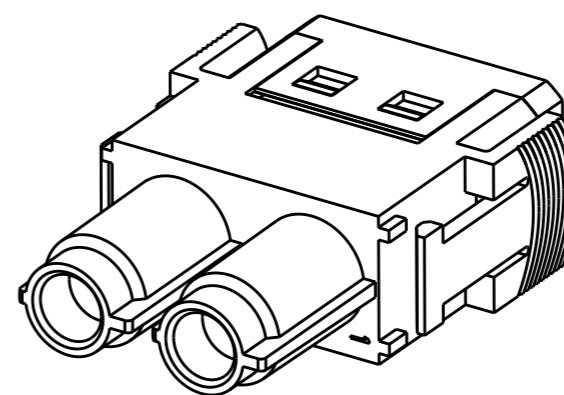
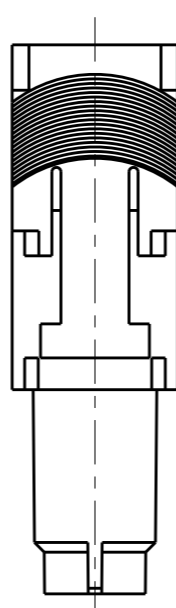
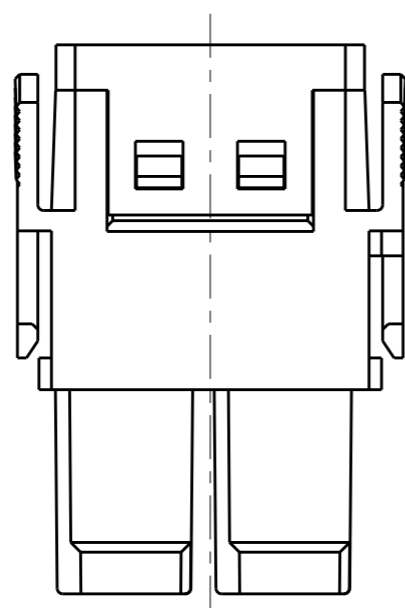
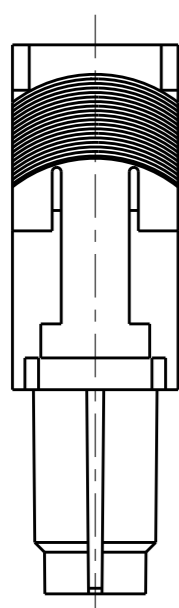

TYPE-2:T2111020201-001 NO LOGO
类型-2:T2111020201-001 NO LOGO

ALL DIMENSIONS ARE SAME AS TYPE 1,
EXCEPT THOSE DEFINED IN THIS TYPE.
除了在本类型中定义的尺寸外,其它尺寸同类型1

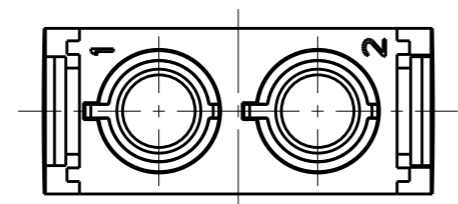

T2111020201-001	HMN-002-FC	HMN-002 FEMALE MODULE INSERT, CRIMPING, NO LOGO HMN-002冷压型模块母插, 无LOGO	TYPE-2 类型-2
T2111020201-000	HMN-002-FC	HMN-002 FEMALE MODULE INSERT, CRIMPING HMN-002冷压型模块母插	TYPE-1 类型-1
PART NUMBER 料号	PART DESCRIPTION 描述		TYPE 类型

THIS DRAWING IS A CONTROLLED DOCUMENT.

DWN 17APR2015
David Wang
CHK 17APR2015
Chris Wang
APVD 17APR2015
Xiang Xu



DIMENSIONS:
mm

TOLERANCES UNLESS OTHERWISE SPECIFIED:

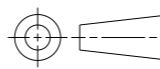

0 PLC ±-
1 PLC ±-
2 PLC ±-
3 PLC ±-
4 PLC ±-
ANGLES ±-

PRODUCT SPEC 108-137059
APPLICATION SPEC 114-137059
WEIGHT -

NAME HMN-002-FC

SIZE CAGE CODE DRAWING NO RESTRICTED TO

A300779 C-T2111020201000 -

MATERIAL - FINISH -

Customer Drawing SCALE 3:2 SHEET 2 OF 2 REV B1