

GMSTBV 2,5/ 4-GF-7,62

Order No.: 1829170

The figure shows a 10-position version of the product

<http://eshop.phoenixcontact.de/phoenix/treeViewClick.do?UID=1829170>

Header, Nominal current: 12 A, Rated voltage (III/2): 630 V, Number of positions: 4, Pitch: 7.62 mm, Color: green, Metal surface: Sn, Assembly: Soldering

Commercial data	
GTIN (EAN)	 4 017918 050931
sales group	E112
Pack	50 pcs.
Customs tariff	85366990
Catalog page information	Page 277 (CC-2009)

Product notesWEEE/RoHS-compliant since:
01/01/2003

<http://www.download.phoenixcontact.com>
Please note that the data given here has been taken from the online catalog. For comprehensive information and data, please refer to the user documentation. The General Terms and Conditions of Use apply to Internet downloads.

Technical data	
Dimensions / positions	
Length	8.6 mm
Pitch	7.62 mm
Dimension a	22.86 mm
Number of positions	4

Pin dimensions	1 x 1 mm
Hole diameter	1.4 mm

Technical data

Range of articles	GMSTBV 2,5/...-GF
Insulating material group	I
Rated surge voltage (III/3)	6 kV
Rated surge voltage (III/2)	6 kV
Rated surge voltage (II/2)	6 kV
Rated voltage (III/2)	630 V
Rated voltage (II/2)	630 V
Connection in acc. with standard	EN-VDE
Nominal current I_N	12 A
Nominal voltage U_N	400 V
Maximum load current	12 A
Insulating material	PA
Inflammability class acc. to UL 94	V0
Nominal voltage, UL/CUL Use Group B	250 V
Nominal current, UL/CUL Use Group B	12 A
Nominal voltage, UL/CUL Use Group D	300 V
Nominal current, UL/CUL Use Group D	10 A

Certificates / Approvals



Certification

CB, CSA, CUL, GOST, UL, VDE-PZI

Accessories

Item	Designation	Description
Assembly		
1755477	MSTB-BL	Keying cap, for forming sections, plugs onto header pin, green insulating material

Marking

0804549	SK 7,62/3,8:FORTL.ZAHLEN	Marker card, printed horizontally, self-adhesive, 10-section marker strip, 12 identical decades marked 1-10, 11-20 etc. up to 91-99, sufficient for 120 terminal blocks
---------	--------------------------	---

Plug/Adapter

1734401	CR-MSTB	Coding section, inserted into the recess in the header or the inverted plug, red insulating material
---------	---------	--

Additional products

Item	Designation	Description
General		
1806009	FRONT-GMSTB 2,5/ 4-STF-7,62	Plug component, Nominal current: 12 A, Rated voltage (III/2): 630 V, Number of positions: 4, Pitch: 7.62 mm, Color: green, Metal surface: Sn
1858785	GMSTB 2,5/ 4-STF-7,62	Plug component, Nominal current: 12 A, Rated voltage (III/2): 630 V, Number of positions: 4, Pitch: 7.62 mm, Color: green, Metal surface: Sn
1847903	GMVSTBR 2,5/ 4-STF-7,62	Plug component, Nominal current: 12 A, Rated voltage (III/2): 630 V, Number of positions: 4, Pitch: 7.62 mm, Color: green, Metal surface: Sn
1848012	GMVSTBW 2,5/ 4-STF-7,62	Plug component, Nominal current: 12 A, Rated voltage (III/2): 630 V, Number of positions: 4, Pitch: 7.62 mm, Color: green, Metal surface: Sn

Diagrams/Drawings

Drilling plan/solder pad geometry

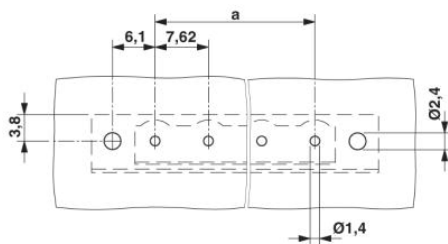

Dimensioned drawing

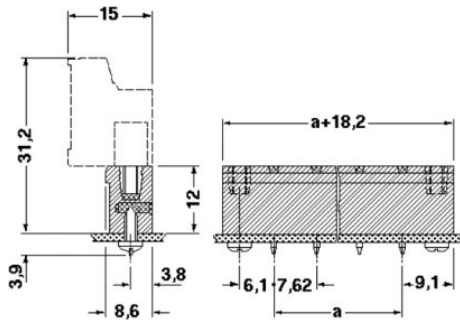

Address

PHOENIX CONTACT Deutschland GmbH
Flachmarktstr. 8
32825 Blomberg, Germany
Phone +49 5235 3 12000
Fax +49 5235 3 41200
<http://www.phoenixcontact.de>



© 2010 Phoenix Contact
Technical modifications reserved;