



Is Now Part of



ON Semiconductor®

To learn more about ON Semiconductor, please visit our website at
www.onsemi.com

ON Semiconductor and the ON Semiconductor logo are trademarks of Semiconductor Components Industries, LLC dba ON Semiconductor or its subsidiaries in the United States and/or other countries. ON Semiconductor owns the rights to a number of patents, trademarks, copyrights, trade secrets, and other intellectual property. A listing of ON Semiconductor's product/patent coverage may be accessed at www.onsemi.com/site/pdf/Patent-Marking.pdf. ON Semiconductor reserves the right to make changes without further notice to any products herein. ON Semiconductor makes no warranty, representation or guarantee regarding the suitability of its products for any particular purpose, nor does ON Semiconductor assume any liability arising out of the application or use of any product or circuit, and specifically disclaims any and all liability, including without limitation special, consequential or incidental damages. Buyer is responsible for its products and applications using ON Semiconductor products, including compliance with all laws, regulations and safety requirements or standards, regardless of any support or applications information provided by ON Semiconductor. "Typical" parameters which may be provided in ON Semiconductor data sheets and/or specifications can and do vary in different applications and actual performance may vary over time. All operating parameters, including "Typicals" must be validated for each customer application by customer's technical experts. ON Semiconductor does not convey any license under its patent rights nor the rights of others. ON Semiconductor products are not designed, intended, or authorized for use as a critical component in life support systems or any FDA Class 3 medical devices or medical devices with a same or similar classification in a foreign jurisdiction or any devices intended for implantation in the human body. Should Buyer purchase or use ON Semiconductor products for any such unintended or unauthorized application, Buyer shall indemnify and hold ON Semiconductor and its officers, employees, subsidiaries, affiliates, and distributors harmless against all claims, costs, damages, and expenses, and reasonable attorney fees arising out of, directly or indirectly, any claim of personal injury or death associated with such unintended or unauthorized use, even if such claim alleges that ON Semiconductor was negligent regarding the design or manufacture of the part. ON Semiconductor is an Equal Opportunity/Affirmative Action Employer. This literature is subject to all applicable copyright laws and is not for resale in any manner.

KSA1281

PNP Epitaxial Silicon Transistor

Features

- Audio Power Amplifier
- 3 W Output Application

ABSOLUTE MAXIMUM RATINGS

(Values are at $T_A = 25^\circ\text{C}$ unless otherwise noted.)

Parameter	Symbol	Value	Unit
Collector–Base Voltage	V_{CB0}	–50	V
Collector–Emitter Voltage	V_{CEO}	–50	V
Emitter–Base Voltage	V_{EBO}	–5	V
Collector Current	I_C	–2	A
Junction Temperature	T_J	150	$^\circ\text{C}$
Storage Temperature	T_{STG}	–55 to +150	$^\circ\text{C}$

Stresses exceeding those listed in the Maximum Ratings table may damage the device. If any of these limits are exceeded, device functionality should not be assumed, damage may occur and reliability may be affected.



ON SemiconductorTM

www.onsemi.com



**TO-92L
CASE 135AM**

PIN CONNECTIONS

1. Emitter 2. Collector 3. Base

ORDERING INFORMATION

See detailed ordering, marking and shipping information on page 2 of this data sheet.

KSA1281

THERMAL CHARACTERISTICS (Note 1)

Symbol	Parameter	Value	Unit
P _D	Power Dissipation T _C = 25°C	1000	mW
	Derate Above T _A = 25°C	8.0	mW/°C
R _{θJA}	Thermal Resistance, Junction-to-Ambient	125	°C/W

1. PCB size: FR-4, 76 mm x 114 mm x 1.57 mm (3.0 inch x 4.5 inch x 0.062 inch) with minimum land pattern size.

ELECTRICAL CHARACTERISTICS (Note 2) Values are at T_A = 25°C unless otherwise noted.

Symbol	Parameter	Conditions	Min	Typ	Max	Unit
BV _{CBO}	Collector-Base Breakdown Voltage	I _C = -1 mA, I _E = 0	-50			V
BV _{CEO}	Collector-Emitter Breakdown Voltage	I _C = -10 mA, I _B = 0	-50			V
BV _{EBO}	Emitter-Base Breakdown Voltage	I _E = -1 mA, I _C = 0	-5			V
I _{CBO}	Collector Cut-Off Current	V _{CB} = -50 V, I _E = 0			-100	nA
I _{EBO}	Emitter Cut-Off Current	V _{EB} = -5 V, I _C = 0			-100	nA
h _{FE1}	DC Current Gain	V _{CE} = -2 V, I _C = -500 mA	120		240	
h _{FE2}		V _{CE} = -2 V, I _C = -1.5 A	40			
V _{BE(sat)}	Base-Emitter Saturation Voltage	I _C = -1 A, I _B = -0.05 A			-1.2	V
V _{CE(sat)}	Collector-Emitter Saturation Voltage	I _C = -1 A, I _B = -0.05 A			-0.5	V
C _{ob}	Output Capacitance	V _{CB} = -10 V, I _E = 0, f = 1 MHz		40		pF
f _T	Current Gain Bandwidth Product	V _{CE} = -2 V, I _C = -500 mA		100		MHz

Product parametric performance is indicated in the Electrical Characteristics for the listed test conditions, unless otherwise noted. Product performance may not be indicated by the Electrical Characteristics if operated under different conditions.

2. Pulse test: pulse width ≤ 300 μs, duty cycle ≤ 2.0%.

ORDERING INFORMATION

Part Number	Top Mark	Package	Packing Method
KSA1281YTA	A1281 Y-	TO-92 3L	Ammo

Typical Performance Characteristics

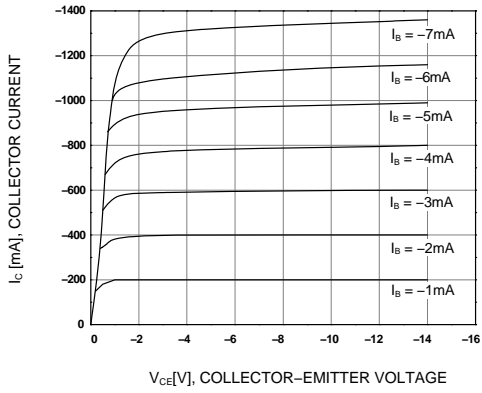

Figure 1. Static Characteristic

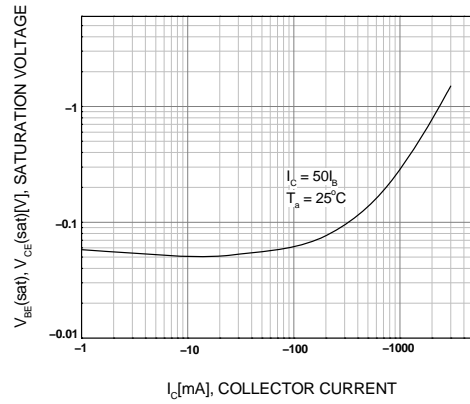

Figure 2. Base-Emitter Saturation Voltage

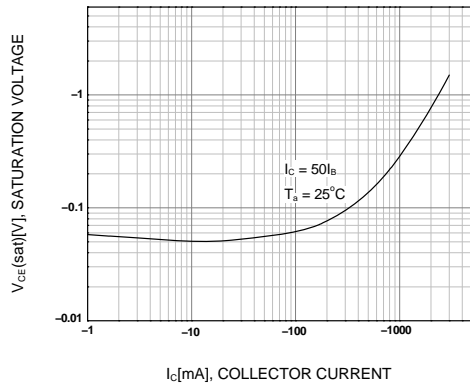

Figure 3. Collector-Emitter Saturation Voltage

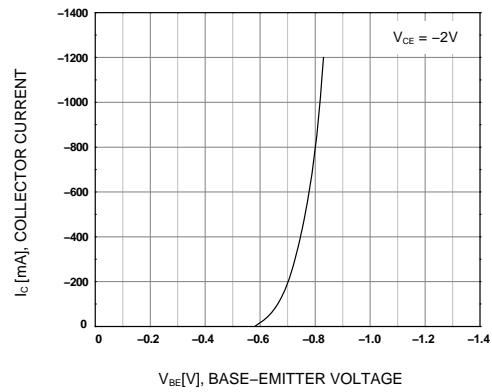

Figure 4. Base-Emitter On Voltage

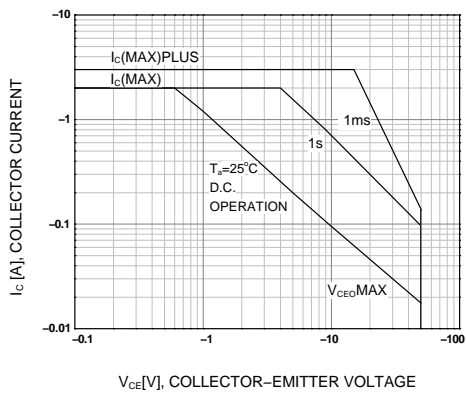

Figure 5. Safe Operating Area

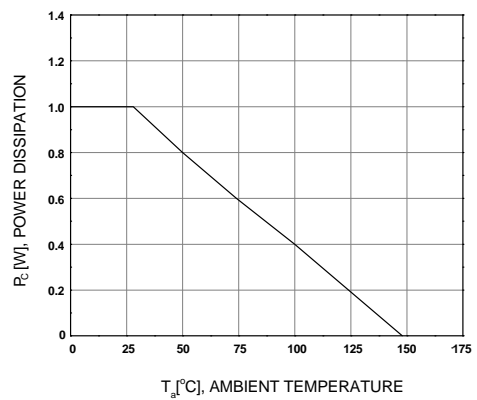
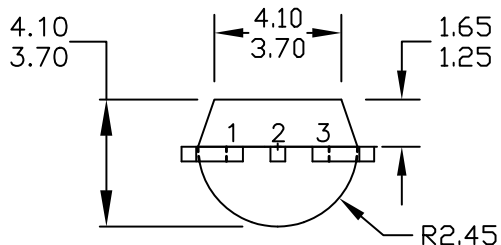
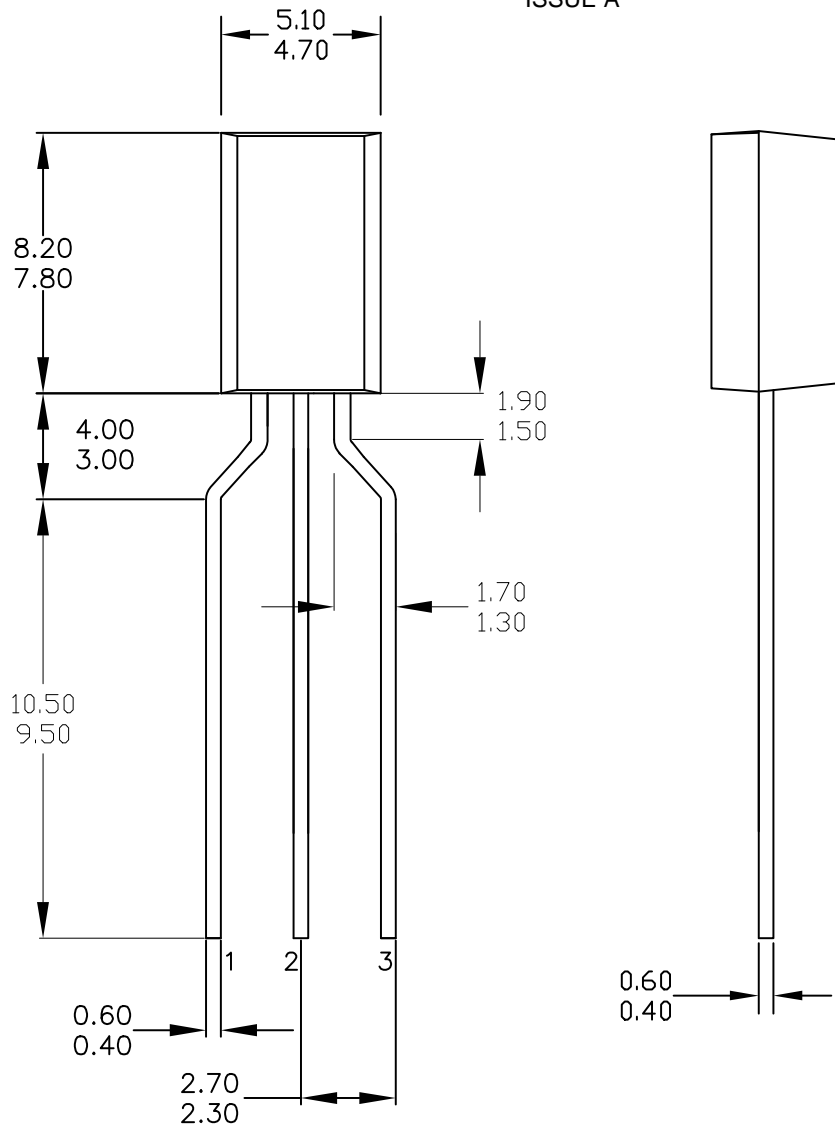

Figure 6. Power Derating

KSA1281

PACKAGE DIMENSIONS

TO-92 3 8.0x4.9 (LEADFORMED)
CASE 135AM
ISSUE A



NOTES: UNLESS OTHERWISE SPECIFIED

- A. THIS PACKAGE IS NOT PRESENTLY REGISTERED WITH ANY STANDARDS COMMITTEE.
- B. DIMENSIONS ARE EXCLUSIVE OF BURRS, MOLD FLASH, AND TIE BAR PROTRUSIONS.
- C. ALL DIMENSIONS ARE IN MILLIMETERS.

ON Semiconductor and  are trademarks of Semiconductor Components Industries, LLC dba ON Semiconductor or its subsidiaries in the United States and/or other countries. ON Semiconductor owns the rights to a number of patents, trademarks, copyrights, trade secrets, and other intellectual property. A listing of ON Semiconductor's product/patent coverage may be accessed at www.onsemi.com/site/pdf/Patent-Marking.pdf. ON Semiconductor reserves the right to make changes without further notice to any products herein. ON Semiconductor makes no warranty, representation or guarantee regarding the suitability of its products for any particular purpose, nor does ON Semiconductor assume any liability arising out of the application or use of any product or circuit, and specifically disclaims any and all liability, including without limitation special, consequential or incidental damages. Buyer is responsible for its products and applications using ON Semiconductor products, including compliance with all laws, regulations and safety requirements or standards, regardless of any support or applications information provided by ON Semiconductor. "Typical" parameters which may be provided in ON Semiconductor data sheets and/or specifications can and do vary in different applications and actual performance may vary over time. All operating parameters, including "Typicals" must be validated for each customer application by customer's technical experts. ON Semiconductor does not convey any license under its patent rights nor the rights of others. ON Semiconductor products are not designed, intended, or authorized for use as a critical component in life support systems or any FDA Class 3 medical devices or medical devices with a same or similar classification in a foreign jurisdiction or any devices intended for implantation in the human body. Should Buyer purchase or use ON Semiconductor products for any such unintended or unauthorized application, Buyer shall indemnify and hold ON Semiconductor and its officers, employees, subsidiaries, affiliates, and distributors harmless against all claims, costs, damages, and expenses, and reasonable attorney fees arising out of, directly or indirectly, any claim of personal injury or death associated with such unintended or unauthorized use, even if such claim alleges that ON Semiconductor was negligent regarding the design or manufacture of the part. ON Semiconductor is an Equal Opportunity/Affirmative Action Employer. This literature is subject to all applicable copyright laws and is not for resale in any manner.

PUBLICATION ORDERING INFORMATION

LITERATURE FULFILLMENT:

Literature Distribution Center for ON Semiconductor
19521 E. 32nd Pkwy, Aurora, Colorado 80011 USA
Phone: 303-675-2175 or 800-344-3860 Toll Free USA/Canada
Fax: 303-675-2176 or 800-344-3867 Toll Free USA/Canada
Email: orderlit@onsemi.com

N. American Technical Support: 800-282-9855 Toll Free
USA/Canada
Europe, Middle East and Africa Technical Support:
Phone: 421 33 790 2910
Japan Customer Focus Center
Phone: 81-3-5817-1050

ON Semiconductor Website: www.onsemi.com
Order Literature: <http://www.onsemi.com/orderlit>

For additional information, please contact your local Sales Representative

ON Semiconductor and  are trademarks of Semiconductor Components Industries, LLC dba ON Semiconductor or its subsidiaries in the United States and/or other countries. ON Semiconductor owns the rights to a number of patents, trademarks, copyrights, trade secrets, and other intellectual property. A listing of ON Semiconductor's product/patent coverage may be accessed at www.onsemi.com/site/pdf/Patent-Marking.pdf. ON Semiconductor reserves the right to make changes without further notice to any products herein. ON Semiconductor makes no warranty, representation or guarantee regarding the suitability of its products for any particular purpose, nor does ON Semiconductor assume any liability arising out of the application or use of any product or circuit, and specifically disclaims any and all liability, including without limitation special, consequential or incidental damages. Buyer is responsible for its products and applications using ON Semiconductor products, including compliance with all laws, regulations and safety requirements or standards, regardless of any support or applications information provided by ON Semiconductor. "Typical" parameters which may be provided in ON Semiconductor data sheets and/or specifications can and do vary in different applications and actual performance may vary over time. All operating parameters, including "Typicals" must be validated for each customer application by customer's technical experts. ON Semiconductor does not convey any license under its patent rights nor the rights of others. ON Semiconductor products are not designed, intended, or authorized for use as a critical component in life support systems or any FDA Class 3 medical devices or medical devices with a same or similar classification in a foreign jurisdiction or any devices intended for implantation in the human body. Should Buyer purchase or use ON Semiconductor products for any such unintended or unauthorized application, Buyer shall indemnify and hold ON Semiconductor and its officers, employees, subsidiaries, affiliates, and distributors harmless against all claims, costs, damages, and expenses, and reasonable attorney fees arising out of, directly or indirectly, any claim of personal injury or death associated with such unintended or unauthorized use, even if such claim alleges that ON Semiconductor was negligent regarding the design or manufacture of the part. ON Semiconductor is an Equal Opportunity/Affirmative Action Employer. This literature is subject to all applicable copyright laws and is not for resale in any manner.

PUBLICATION ORDERING INFORMATION

LITERATURE FULFILLMENT:

Literature Distribution Center for ON Semiconductor
19521 E. 32nd Pkwy, Aurora, Colorado 80011 USA
Phone: 303-675-2175 or 800-344-3860 Toll Free USA/Canada
Fax: 303-675-2176 or 800-344-3867 Toll Free USA/Canada
Email: orderlit@onsemi.com

N. American Technical Support: 800-282-9855 Toll Free
USA/Canada
Europe, Middle East and Africa Technical Support:
Phone: 421 33 790 2910
Japan Customer Focus Center
Phone: 81-3-5817-1050

ON Semiconductor Website: www.onsemi.com
Order Literature: <http://www.onsemi.com/orderlit>
For additional information, please contact your local
Sales Representative